

2.02 - Democracy Suite[®] System Overview

Version: 5.11-CO::7

June 5, 2019

Table of Contents

Chapter 1: Introduction	1
1.1 Document Use	1
1.2 Relevant Disclaimers	2
1.3 Purpose and Scope	2
1.4 Document Organization	3
1.5 Design Responsibility	3
1.6 Document Status	3
1.7 Patent Status	3
Chapter 2: System Overview	4
2.1 Democracy Suite [®] Overview	4
2.1.1 Languages Supported by Democracy Suite [®]	7
2.2 Democracy Suite [®] Election Management System (EMS)	9
2.3 ImageCast [®] Precinct Ballot Counter	14
2.3.1 Ballot Scanning and Processing	15
2.3.2 Audio Voting, AVS Voting, and Ballot Marking Options	16
2.3.3 Ballot Review and Second Chance Voting	16
2.4 ImageCast [®] Evolution Ballot Counter	17
2.4.1 Ballot Scanning and Tabulation	18
2.4.2 Ballot Review and Second Chance Voting	19
2.4.3 Accessible Voting and Ballot Marking	19
2.4.4 Using ImageCast [®] Devices with ImageCast [®] X Electronic Mobile Ballots	21
2.5 ImageCast [®] Central Ballot Counter	22
2.6 ImageCast [®] Remote	23
2.6.1 Ballot Marking	24
2.6.1.1 Ballot Review and Second Chance Voting	24
2.6.1.2 Electronic Mobile Ballot	24
2.6.1.3 Accessible Voting	25
2.7 ImageCast [®] X	26
2.7.1 Ballot Marking - BMD Mode	26
2.7.1.1 Electronic Mobile Ballot	27
2.7.2 Ballot Marking - DRE Mode	28

2.7.2.1 VVPAT Ballot 29

2.7.3 Ballot Review and Second Chance Voting 29

2.7.4 AVS Voting Session 30

2.8 AuditMark® 31

2.9 Democracy Suite® Logical Deployment View 31

2.10 Democracy Suite® Physical Deployment View 33

Chapter 3: Operational Environment 34

3.1 Democracy Suite® EMS Operational Environment 34

3.1.1 EMS Hardware Configuration 36

3.1.1.1 EMS Express Hardware Configuration 36

3.1.1.2 EMS Standard Hardware Configuration 37

3.1.2 EMS Software Configuration 38

3.1.2.1 EMS Express Software Configuration 38

3.1.2.2 EMS Standard Software Configuration 40

3.2 ImageCast® Precinct Operational Environment 41

3.2.1 Functional Elements 42

3.2.2 Safety and Compliance 43

3.2.3 Environmental 44

3.2.4 Data Network 44

3.2.5 Input Power 45

3.2.6 Physical Access Control 45

3.2.6.1 Door Coverage 45

3.2.6.2 Security 45

3.3 ImageCast® Evolution Operational Environment 45

3.3.1 Functional Elements 46

3.3.2 Safety and Compliance 49

3.3.3 Environmental 49

3.3.4 Data Network 50

3.3.5 Input Power 50

3.3.6 Physical Access Control 50

3.3.6.1 Door Coverage 50

3.3.6.2 Security 50

- 3.4 ImageCast® Central Operational Environment 51
 - 3.4.1 Functional Elements 51
 - 3.4.2 Scanner Safety and Compliance 51
 - 3.4.2.1 FCC Compliance 51
 - 3.4.3 Workstation Safety and Compliance 51
 - 3.4.4 Environmental 51
 - 3.4.5 Data Network 52
 - 3.4.6 Input Power 52
- 3.5 ImageCast® Remote Operational Environment 52
 - 3.5.1 Software Configuration 52
- 3.6 ImageCast® X Operational Environment 52
 - 3.6.1 Hardware Configuration 54
 - 3.6.2 Software Configuration 56
 - 3.6.3 Physical Interfaces 56

Chapter 4: External and Internal Interfaces 57

- 4.1 Democracy Suite® EMS Logical Interfaces 57
- 4.2 Democracy Suite® EMS Physical Interfaces 61
- 4.3 ImageCast® Evolution Logical Interfaces 62
- 4.4 ImageCast® Precinct Logical Interfaces 63
- 4.5 ImageCast® Precinct Physical Interfaces 64
 - 4.5.1 I/O Ports 64
 - 4.5.1.1 RS232 Port 64
 - 4.5.1.2 Modem Port 64
 - 4.5.2 Integrated USB Port 64
 - 4.5.3 Power Input 64
 - 4.5.4 Removable Memory 64
 - 4.5.5 Security Interface 64
- 4.6 ImageCast® Evolution Physical Interfaces 65
 - 4.6.1 I/O Ports 65
 - 4.6.1.1 RS232 port 65
 - 4.6.1.2 AVS Vote - Accessibility Port 65
 - 4.6.1.3 USB Port 65

4.6.2 Power Input	65
4.6.3 Removable Memory	65
4.6.4 Security Interface	65
4.7 ImageCast® Central Logical Interfaces	66
4.8 ImageCast® Central Physical Interfaces	66
4.9 ImageCast® Remote Logical Interfaces	66
4.10 ImageCast® X Logical Interfaces	67
4.11 ImageCast® X Physical Interfaces	68
4.12 Benchmark Directory	68
4.12.1 Democracy Suite® EMS Software Release Package	68
4.12.2 Democracy Suite® ImageCast® Evolution Firmware Release Package 73	
4.12.3 Democracy Suite® ImageCast® Precinct Firmware Release Package . 73	
4.12.4 Democracy Suite® ImageCast® Central Count Application Software Release Package	73
4.12.5 Democracy Suite® ImageCast® X Software Release Package	73
Chapter 5: System Performance	74
5.1 System Capacity	74
5.1.1 Democracy Suite® EMS System Capacity	74
5.1.2 ImageCast® Evolution System Capacity	76
5.1.3 ImageCast® Precinct System Capacity	78
5.1.4 ImageCast® Central Count System Capacity	79
5.1.5 ImageCast® X System Capacity	79
5.2 Quality Attributes	80
5.2.1 Democracy Suite® EMS Quality Attributes	80
5.2.1.1 Reliability	80
5.2.1.2 Maintainability	82
5.2.1.3 Availability	82
5.2.1.4 Usability	82
5.2.1.5 Portability	83
5.2.2 ImageCast® Evolution and ImageCast® Precinct Ballot Counter Quality Attributes	83

5.2.2.1 Reliability	83
5.2.2.2 Maintainability	84
5.2.2.3 Availability	84
5.2.2.4 Usability	85
5.2.2.5 Portability	85
5.2.3 ImageCast® Central Ballot Counter Quality Attributes	85
5.2.4 ImageCast® X Voting Terminal Quality Attributes	85
5.2.5 Democracy Suite® Security Attributes	85
5.2.5.1 Safety	85
5.2.5.2 Security	86
5.2.5.3 Privacy	87
5.2.5.4 Continuity of Operation	87
5.2.6 Democracy Suite® System Constraints	87
5.2.6.1 Design Constraints	87
5.2.6.2 Applicable Standards	87
5.2.6.3 Compatibility	88
5.2.7 ImageCast® Evolution System Constraints	89
5.2.7.1 Continuity of Operation	89
5.2.7.2 Design Constraints	89
5.2.7.3 Applicable Standards	89
5.2.8 ImageCast® Precinct System Constraints	89
5.2.8.1 Continuity of Operation	89
5.2.8.2 Design Constraints	90
5.2.8.3 Applicable Standards	90
5.2.8.4 Compatibility	90
5.2.9 ImageCast® Central System Constraints	90
5.2.9.1 Design Constraints	90
5.2.9.2 Applicable Standards	90
5.2.9.3 Compatibility	90
5.2.10 ImageCast® X System Constraints	91
5.2.10.1 Continuity of Operation	91
5.2.10.2 Design Constraints	91

5.2.10.3 Applicable Standards 91

5.2.10.4 Compatibility 91

Revision History 92

List of Figures 93

List of Tables 94

VVSG Trace List 95

CHAPTER 1: INTRODUCTION

Dominion Voting Systems' Democracy Suite® 5.11 platform expands on the following EAC-certified components from the Democracy Suite® 5.2 platform. Each component's upgrades are discussed in further detail within 2.13 -

Democracy Suite® System Change Notes:

- Democracy Suite® Election Management System (EMS) software platform
- Democracy Suite® ImageCast® Central (ICC) optical ballot counter
- Democracy Suite® ImageCast® X (ICX) ballot marking platform

The Democracy Suite® Election Management System (EMS) represents a set of N-Tier software applications for pre-voting and post-voting election project activities that are applicable to jurisdictions of various sizes and geo-political complexities. The Democracy Suite® EMS platform is available in two hardware configurations, Express and Standard, which are described in detail in the following chapters.

The Democracy Suite® ImageCast® Central system consists of a central, high-speed, optical scan ballot counter (tabulator) called the ImageCast® Central Ballot Counter and is used for processing absentee ballots (such as vote by mail). This ballot counter unit is based on COTS hardware coupled with custom made ballot processing application software. It is used for high-speed, accurate and reliable centralized scanning and counting of paper ballots.

The Democracy Suite® ImageCast® X ballot marking platform is a solution that is used for creation of paper Electronic Mobile Ballots. These ballots are later scanned and tabulated by the ImageCast® Central optical ballot counter and/or scanned, verified and cast on the ImageCast® Precinct. The ImageCast® X also supports enhanced accessibility voting through optional accessories connected to the ImageCast® X unit

1.1 Document Use

This document is intended for use with the Democracy Suite® 5.11 platform.

1.2 Relevant Disclaimers

Please be advised that this Technical Data Package (TDP) may make reference to Democracy Suite® functionalities listed below. These functionalities are not components of the current Democracy Suite® 5.11-CO certification campaign, and should be disregarded throughout the TDP.

- AIMS Data Translator
- Canon imageFORMULA DR-M260
- EMS Enterprise Configuration
- Election Data Exchange Station (EDES)
- EMS Results Transfer Manager
- Golden Disc Images
- ImageCast® Evolution
- ImageCast® Evolution Dual Monitor Functionality
- ImageCast® Listener
- ImageCast® Precinct
- ImageCast® Precinct Ballot Marking Device (BMD)
- ImageCast® Precinct BMD Audio
- ImageCast® Remote
- ImageCast® X DRE
- ImageCast® X DRE with VVPAT
- Mode 2 asymmetric cryptography
- Mode 4 asymmetric cryptography
- Modem and transmission functionality
- WinEDS™ Importer

1.3 Purpose and Scope

This document overviews the Democracy Suite® 5.11 system and does not cover detailed system functional characteristics, design, security and test specifications, or operation procedures of the Democracy Suite® components.

1.4 Document Organization

This document is organized as follows:

- Chapter 1 Introduction: Provides introductory information about the Democracy Suite[®] system, as well as a list of applicable specification documents contained within the TDP.
- Chapter 2 System Overview: Provides a summary of the primary components and features of the system. It also includes descriptions of the logical and physical deployment scenarios of the Democracy Suite[®] system.
- Chapter 3 Operational Environment: Identifies all hardware and software products and communication services used in the operation of the Democracy Suite[®] system.
- Chapter 4 External and Internal Interfaces: Provides a description of logical and physical interfaces, as well as interfaces among external and internal components of the system. In addition, this section provides a benchmark directory listing of all files delivered within a single release of the Democracy Suite[®] system.
- Chapter 5 System Performance: Includes an overview of the performance, quality, and security metrics for the system, with additional emphasis on system constraints.

1.5 Design Responsibility

Dominion Voting is the design authority.

1.6 Document Status

This is a working specification for discussion and analysis. Details are subject to change.

1.7 Patent Status

Certain system concepts, as well as many implementation and construction details, are protected by a series of U.S. and foreign patents pending.

CHAPTER 2: SYSTEM OVERVIEW

2.1 Democracy Suite® Overview

The primary function of the Democracy Suite® set of products and solutions is to help election organizations, their officials, and designees define and organize elections. Figure 2-1 illustrates Democracy Suite® components and their relationships.

NOTE: Not all depicted components are applicable for your jurisdiction. Please refer to the relevant Disclaimers page for exceptions.

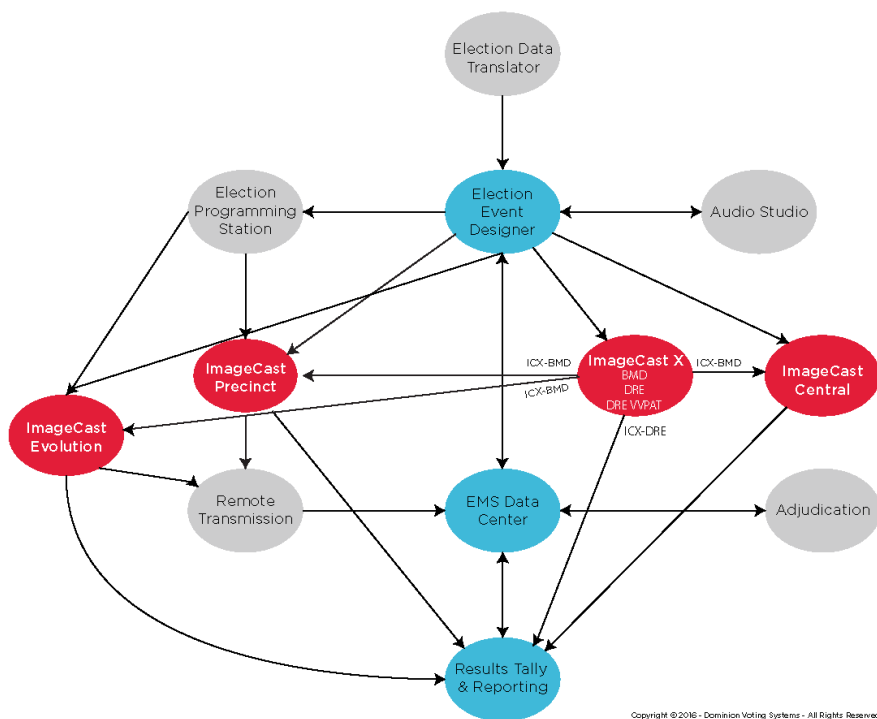

Figure 2-1: Relationship Between the Democracy Suite® Components

The functions provided by Democracy Suite® for achieving these tasks can be grouped into the following main activities and activity groups:

- Pre-Voting Activities:
 - Definition of political divisioning, hierarchical structure, attributes, and associations.
 - Definition of election events along with associated attributes such as election name, date, type, contests, candidates, questions/measures, voting locations, etc.

- Design, preparation and production of paper and AVS (Accessible Voting Session) ballots for polling place and absentee voting.
- Configuration and programming of the ImageCast® series of Precinct and Central ballot counters and ImageCast® X ballot marking terminals.
- Creation of auditing, election definition, and system level reports.
- Support of administrative functions for database, user, networking, and system management.
- Voting - Polling Place Voting:
 - Secure administration and deployment of precinct-level optical tabulation devices.
 - Secure administration and deployment of ImageCast® X ballot marking sets, zero tape printing, opening of polls.
 - Configuration of tabulators, zero tape printing, opening of polls.
 - Allowing voters to cast their paper ballots using optical tabulators.
 - Allowing voters to mark and print their Electronic Mobile Ballots using ImageCast® X.
 - Allowing running standard and accessible voting session in parallel when secondary COTS based USB 2.0 to VGA monitor is connected (ImageCast® Evolution only).
 - Second-chance review using the integrated ballot review functionality.
 - Providing a usable and practical voting interface to voters with disabilities.
 - Separation of paper ballots (depending on pre-defined criteria) into separate ballot box compartments.
 - Secure tabulation, storage, and reporting of election results for a given polling station.
 - Printing of precinct-level reports and consolidated results at the polling station.
 - Closing of the polling place.
- Voting - Absentee (remote) Voting:
 - Receiving, unpacking and verifying absentee ballots.
 - Secure administration and deployment of central optical tabulation devices.
 - Configuration of device and network communication settings.
 - Scheduling of ballots for processing using the ImageCast® Central optical scanner.

- Scanning of ballots in batches.
- Closure of the central e-Counting session and creation of applicable reports.
- Post-Voting Activities:
 - Acquisition, import or manual data entry of election results from the ImageCast[®] series of tabulation devices.
 - Adjudication of ballots/vote results.
 - Preview and validation of election results.
 - Creation of election results according to voting variations and election system rules.
 - Generation of election result reports in the desired format.
 - Publication of unofficial election results for further processing or reporting (i.e. news and media feeds).
 - Generation of artifacts for use in canvassing, recounts or election audits.

2.1.1 Languages Supported by Democracy Suite®

The following languages are supported by Democracy Suite® 5.11

Language	ICE	ICP	ICR	ICX
Alaska Native	Yes, if using Latin alphabet	Yes	No	No
Apache	Audio only	Audio only	No	No
Bengali	Yes	Yes	No	Yes
Chinese	Yes	Yes	Yes	Yes
English	Yes	Yes	Yes	Yes
Eskimo	Yes, if using Latin alphabet	Yes	No	No
Filipino	Yes, if using Latin alphabet	Yes	Yes	No
French	Yes	Yes	Yes	Yes
Hindi	Yes	Audio only	Yes	Yes
Japanese	Yes	Yes	Yes	Yes
Jicarilla	Audio only	Audio only	No	No
Keres	Audio only	Audio only	No	No
Khmer	Yes	Audio only	Yes	No
Korean	Yes	Yes	Yes	Yes
Navajo	Audio only	Audio only	No	No
Seminole	Audio only	Audio only	No	No
Spanish	Yes	Yes	Yes	Yes
Tagalog	No	No	No	Yes
Thai	Yes	Audio only	Yes	Yes
Towa	Audio only	Audio only	No	No
Ute	Audio only	Audio only	No	No
Vietnamese	Yes	Yes	Yes	Yes
Yuman	Audio only	Audio only	No	No

Table 2-1: Languages Supported by Democracy Suite 5.11

The ICP tabulator's LCD screen is capable of displaying voter messages in a variety of languages with the use of customized language files. For more

information, please see the Democracy Suite[®] EMS Election Event Designer User Guide, Section 4.12 ICP Voter Display Message Language Customization.

The EMS system supports any language by defining Language Profiles. Default language is English, but it is possible to define more than one language for every language profile. Depend of purpose, the EMS system handles four different language profiles:

- **Ballot Content:** Refers to written text which is rendered on artwork for paper ballots. In most cases, this depends on the type of script that the language is written in. The following are currently supported:
 - Chinese (Simplified)
 - Cyrillic
 - Latin-based
 - Ligature-based

Below is a list of fonts to be used when rendering ballots that contain specific languages:

Language	Fonts	Render Text as Image
English	In general, all fonts used for Latin languages are acceptable	No
Spanish	In general, all fonts used for Latin languages are acceptable	No
Tagalog	In general, all fonts used for Latin languages are acceptable	No
Khmer	Any font that can handle Khmer language because text is rendered as image. Tested with: Khmer UI.	Yes
Korean	Malgun Gothic, Gulim	No
Vietnamese	In general, all Unicode fonts used for Latin languages are acceptable. Tested with: Arial, Helvetica, Verdana, Calibri	No
Hindi	Any font that can handle Hindi language because text is rendered as image. Tested with: Mangal, Arial Unicode MS.	Yes

Table 2-2: Fonts to be used when rendering ballots that contain specific languages

Language	Fonts	Render Text as Image
Japanese	Microsoft JhengHei, MS Mincho	No
Filipino	In general, all fonts used for Latin languages are acceptable	No
Chinese	PMingLiU, MingLiU, SimSun	No
Bengali	Vrinda	Yes
Punjabi	Raavi	Yes

Table 2-2: Fonts to be used when rendering ballots that contain specific languages
(Continued)

- **Base/Audio:** Refers to spoken language and in most cases relates to generated audio for tabulator Accessible Voting Sessions (AVS). EMS supports any recorded language that can be imported from an external source as audio files the most typical cases are when spoken-only language (e.g. Navajo) is required. In addition to that, users are able to generate audio using EMS in any available language using the third party Cepstral tool voices.
- **Screen Content:** Refers to tabulator screen content for ImageCast X tabulators.
- **Print Content:** Refers to print content for ImageCast X tabulators. It will be used when electronic mobile ballot is printed, or data displayed on VVPAT.

2.2 Democracy Suite[®] Election Management System (EMS)

The Democracy Suite[®] Election Management System (EMS) set of applications are responsible for all pre-voting and post-voting groups of activities in the process of defining and managing elections. The complete EMS software platform consists of client (end-user) and server (back-end) applications as follows:

- **EMS Adjudication:** Server and client components responsible for adjudication, including reporting and generation of adjudicated result files from ImageCast[®] Central tabulators.
- **EMS AIMS Data Translator:** End-user application that transfers election definitions from Democracy Suite[®] to EMS to AIMS, enabling users to program AutoMARK[®] devices for ImageCast[®] ballots.

- EMS Application Server server application: Server side application responsible for executing long running processes, such as rendering ballots, generating audio files and election files, etc.
- EMS Audio Studio client application: End-user helper application used to record audio files for a given election project. As such, it is utilized during the pre-voting phase of the election cycle.
- EMS Data Center Manager server application: System level configuration application used in EMS back-end data center configuration.
- EMS Database Server: Server side RDBMS repository of the election project database which holds all the election project data, including pre-voting and post-voting data.
- EMS Election Data Exchange Station (EDES) client application: End-user helper application used to program the memory cards and iButton security keys required to properly operate the ImageCast[®] series of counting devices. As such, it is utilized during the pre-voting phase of the election cycle.
- EMS Election Data Translator client application: End-user application used to export election data from election project and import election data into election project.
- EMS Election Event Designer[™] client application: Integrates election definition functionality together with ballot styling capabilities and represents a main pre-voting phase end-user application.
- EMS File System Service client application: Stand-alone service that runs on client machines, enabling access to low level operating system API for partitioning CF cards, reading raw partition on ICP CF card, etc.
- ImageCast[®] Listener Server: Set of server and client components, responsible for the authentication, verification and validation of the results transmitted via wireless for both ImageCast[®] Precinct and ImageCast[®] Evolution tabulators during the election.
 - Cartridge Management Service: Backend Windows service, installed on the EMS server, that processes results transmissions that have been saved in the EMS Queue database by the Listener Service.
 - EMS Shell Service: Web service, installed on the EMS server, that supports authentication and logging for the Transmission Dashboard.
 - EMS Service: iWeb service, installed on the EMS server, that provides data from the EMS system required for the ImageCast[®] Listener (such as tabulator data etc.)
 - Listener Service: TCP/IP server implemented as a Windows service, installed on the Listener server, which can receive results transmissions (from ICP machines, ICE machines, or RTM clients) and saves them in the EMS Queue database.

- DVS Transmission Dashboard: End-user Windows application, installed on the EMS client, that allows an administrator to view the status of the transmissions, and to monitor the Listener and Cartridge Manager services.
- EMS NAS Server: Server side file repository of the election project file-based artifacts, such as ballots, audio files, reports, log files, election files, etc.
- EMS Results Tally and Reporting[™] client application: Integrates election results acquisition, validation, tabulation, reporting, and publishing capabilities and represents a main post-voting phase end-user application.
- EMS Result Transfer Manager client application: Stand-alone application used to transfer result files from the remote locations to one or more central locations where the results can be tallied and reported on.
- Smart Card Helper service: Installed on a workstation or laptop at the polling place and provides required data format for programming smart cards for ImageCast[®] devices, or, for jurisdiction's voting registration system in case of integration.
- ImageCast[®] Voter Activation application: Installed on a workstation or laptop at the polling place, that allows the poll workers to program smart cards for voters. The smart cards are used to activate voting sessions on ImageCast[®] X.
- EMS Mobile Ballot Production application: is a Windows application that is used to search, preview and print ballots via a local printer device. The application makes use of ballot information and PDF's produced by the Election Event Designer (EED) application and minimizes the time it takes to search for, and print the ballots required for the election. It allows the voter who is unable to vote at their designated polling location, to go to any other location which supports this functionality and cast their vote.
- EMSLogger: is a stand-alone application that runs on client or server machines and is used to gather diagnostics for troubleshooting.

Figure 2-2 shows a simplified, high-level logical block diagram of the Democracy Suite[®] system. The diagram includes EMS software components as well as the ImageCast[®] series of ballot marking and counting devices. The diagram also contains election domain stakeholders, such as election administrative personnel and voters.

NOTE: Not all depicted components are applicable for your jurisdiction. Please refer to the relevant Disclaimers page for exceptions.

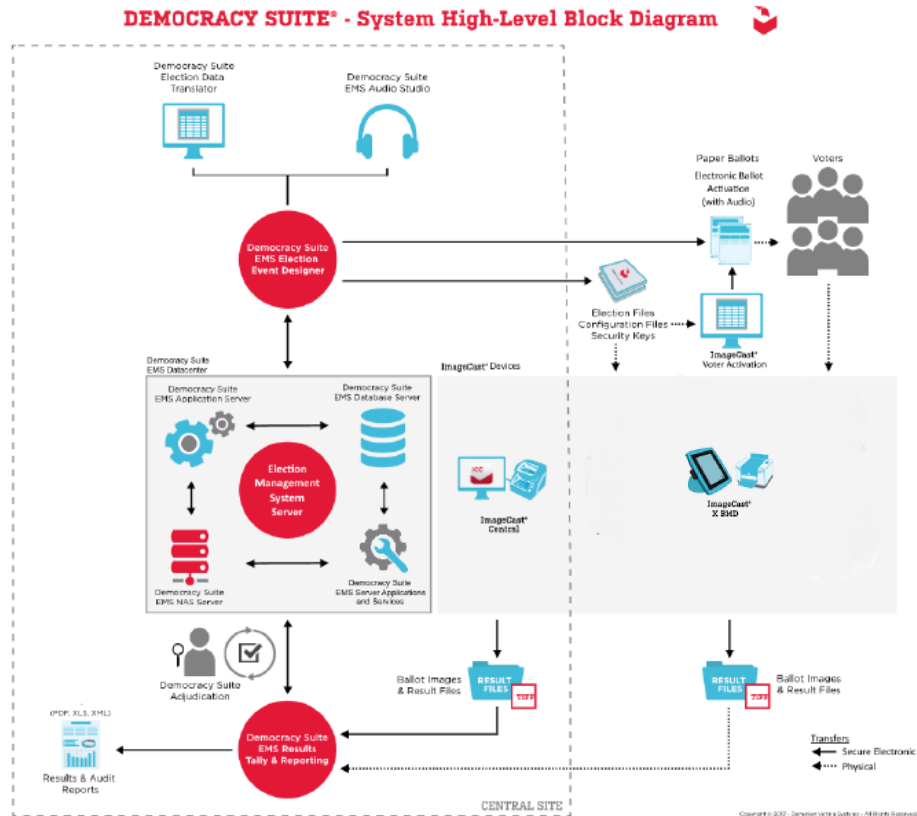

Figure 2-2: Democracy Suite® High-level Block Diagram

As shown in Figure 2-2, election administrative officers and their designees use the Democracy Suite® EMS EED client application to define election projects. Through this process, election definition data can be typed in or imported from external sources. After election data is defined, the system also allows users to define ballot styling parameters and record/synthesize the corresponding audio files. Users can either utilize the audio synthesis capabilities of the EMS platform, or the audio recording capabilities of the EMS Audio Studio client application to perform this process. As a primary output, this process provides ready to print ballot artwork, and if configured to do so, electronic ballots and audio files for AVS (Accessible Voting Session) voting.

The last step in election project definition is the generation of election definition and device behavioral and configuration files. This process analyzes the correlation between voting locations, geo-political divisioning, and all election event related data, such as ballots, contests, and candidates. In doing so, it creates a set of files for each instance of the ImageCast® device. These files are used to program memory cards and security keys (iButtons and/or Smart Cards) for a particular election event. The EMS EED application provides integrated memory

card and security key programming functionality. This integrated programming allows for one card/key to be programmed at a time. Alternatively, jurisdictions can use the EMS EDES application and programming station which programs up to twenty memory cards at a time.

Before produced ballots, memory cards, and security keys are used, the jurisdictions are required to perform logic and accuracy testing to confirm that the system is ready for election day deployment. On election day, jurisdictions can use ImageCast[®] Evolution or ImageCast[®] Precinct in conjunction with ImageCast[®] X Ballot Marking Devices for polling place voting or ImageCast[®] Central ballot counters for central site processing of absentee, early voting, or vote-by-mail ballots.

No matter which ImageCast[®] tabulator is used to count ballots, each is designed to provide a set of results files, log files, and scanned ballot images. These files are acquired by the EMS RTR client application. This application is used to validate, tally, report and publish election results.

NOTE: EMS utilizes commercial off the shelf laser printers compatible with the Microsoft Windows operating system capable of producing the full range of alphanumeric characters to properly print audit entries as well as election, office, and issue headers and labels.

Additionally, results from any ImageCast[®] device may be processed through the EMS Adjudication system. This processing happens prior to publishing results in the EMS RTR client. EMS Adjudication updates both result files and ballot images to reflect actions taken by election officials. The EMS Adjudication system provides its own summary and activity reporting in addition to that provided by the EMS RTR client.

2.3 ImageCast® Precinct Ballot Counter

The ImageCast® Precinct Ballot Counter device is a precinct optical scan ballot counter (also commonly referred to as a tabulator in the election industry) (see Figure 2-3). It is designed to provide three major functionalities:

- Ballot scanning and tabulation
- Accessible voting
- Ballot review and second chance voting



Figure 2-3: The ImageCast® Precinct Ballot Counter

Before any of these functions can take place, the tabulator first goes through a startup procedure that initializes all hardware and all software modules, authenticating the firmware and all external election files.

1. The startup process of the tabulator consists of the following steps:
 - a. The processor loads the boot loader from the onboard flash memory.
 - b. The boot loader loads the uClinux operating system from the onboard flash memory.
 - c. The operating system initializes the hardware and subsystems. (SDRAM, serial devices, buses, interrupts lines, driver modules, file system, system time, etc.)

- d. The operating system verifies and starts the election application from the onboard flash memory.
2. The startup procedure of the election application consists of the following steps:
 - a. Initialize all hardware devices and run diagnostics.
 - b. Initialize all software modules.
3. Once the system startup phase is completed, the main processor cycles through an event loop while it waits for key events to take place. These events include:
 - a. Paper sensor triggered to inform the application that a ballot has been inserted.
 - b. An Administrative iButton Security Key inserted to inform the application that the administrator needs to activate certain administrative actions (start AVS voting session, print log report, enable test ballot state, close the poll, shutdown the system, etc.).
 - c. Check the battery signal interrupt.
 - d. Check for critical events (compact flash ejected, memory failure, etc.)

2.3.1 Ballot Scanning and Processing

Once the first paper sensor is triggered, indicating a ballot is in the ingress slot, the event loop in the main processor will notify the firmware module responsible for scanning. This module scans the ballot by synchronously using the stepper motor, the remaining paper sensors, and the image sensors. The tabulator scans the ballot with two scan heads: one for the top and one for the bottom. The image sensors provide 1728 pixels per scan line with a resolution of 200 pixels per inch horizontally. Vertically, the stepper motors and transport allow for a resolution of approximately 195 pixels per inch. The scanner driver scans the ballot and puts two images (top and bottom) in SDRAM for processing. This processing consists of the following steps.

1. Validate the images scanned are of a valid ballot, and, if enabled, check for the presence of secure infrared (IR) paper stock elements.
2. Determine the ballot barcode and verifying, by referring to the election files, that the ballot scanned should be accepted by the tabulator

3. Determine which voting marks are filled

Once that ballot has been processed, the results are stored redundantly in two formats on two separate memory cards. If one memory card fails, the machine will shut down to ensure that two functioning cards are always present while the machine is in operation.

During this entire process, any ballot processing error or voting errors are reported to the voter, and he/she is given the opportunity to accept or reject the ballot.

Before the ballot is dropped into the ballot box, a summary screen displays the machine's interpretation of the votes on the ballot. The voter is then given the opportunity to verify their ballot.

2.3.2 Audio Voting, AVS Voting, and Ballot Marking Options

The ImageCast[®] Precinct Ballot Counter also allows a voter to cast a ballot via an audio device. The audio voting capability of the tabulator allows the voter to listen to and vote for all names on the ballot. Using the audio assisting device (which is connected to the tabulator), the voter listens to an audio voting session.

The audio assisting device allows the voter to adjust the volume of the audio, change the speed of the audio playback, jump to the next and go back to the previous name, and to cast a vote.

To start an audio voting session, the administrator inserts the iButton security key and selects the appropriate option.

Next, the administrator enters the ballot ID of the ballot to be used for voting. Because the tabulator allows paper ballots to be cast during an audio voting session, the audio session takes place on a separate processing thread on the processor.

At the end of an audio voting session, a summary of the votes is played back to the voter to allow the voter to verify their selection is correct.

2.3.3 Ballot Review and Second Chance Voting

The ImageCast[®] Precinct platform integrates an optional ballot review function. The ballot review feature allows voters to review their selections and change any votes by remarking the ballot. Once a paper ballot is processed, the voting results for a given ballot are displayed on the LCD for verification. The results are presented in text format, which allows voters to easily identify any voting errors they may have made and to verify that the tabulator has correctly identified the selections.

For an AVS voting session, the same verification is performed by going through an audio summary of the votes cast. The voter can accept or reject the ballot before it is cast.

2.4 ImageCast® Evolution Ballot Counter

The ImageCast® Evolution Ballot Counter device (Figure 2-4) is a precinct-level, optical scan, ballot counter (tabulator) designed to perform three major functions:

- Ballot scanning and tabulation
- Ballot review and second chance voting
- Accessible voting and ballot marking

The following images show the ImageCast® Evolution device in operating position (Figure 2-4) and in storage position (Figure 2-5). Detailed hardware design specifications are provided in *2.04 - Democracy Suite® ImageCast® Evolution System Hardware Characteristics*, while the functional specifications are provided in *2.03 - Democracy Suite® ImageCast® Evolution Functionality Description*.

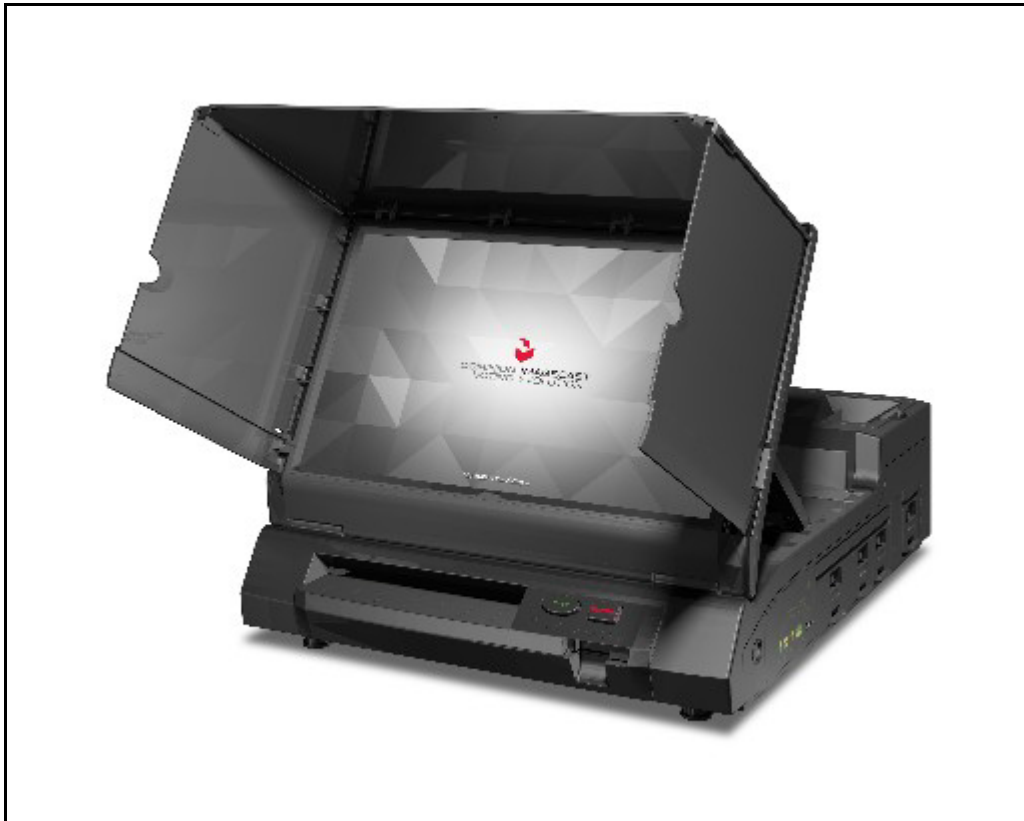

Figure 2-4: ImageCast® Evolution Ballot Counter in Operating Position.



Figure 2-5: ImageCast[®] Evolution Ballot Counter in Storage Position.

It is important to note that the system integrates a comprehensive set of security measures that address access control, physical device tampering, user authentication and authorization, and data confidentiality and integrity.

2.4.1 Ballot Scanning and Tabulation

The primary function of the ImageCast[®] Evolution ballot counter device is to scan and tabulate paper ballots. The device integrates dual CIS (Contact Imaging Sensor) analog scan heads in order to simultaneously scan both the top and bottom of the ballot. Each scan head provides a scan line resolution of 1728 pixels per inch with a horizontal resolution of 200 pixels per inch. Vertically, the stepper motor and paper transport allow for a resolution of approximately 200 pixels per inch. In addition to dual analog scan heads, stepper motor, and paper transport, the overall ballot paper handling mechanism integrates numerous paper sensors and paper diverters. These sensors are used to detect paper insertion and control and monitor paper inside the transport. Operational control of the paper handling and scanning mechanism is the responsibility of the integrated Field Programmable Gate Array (FPGA) hardware chip on the scanner controller board and the embedded firmware that controls the overall process.

The acquisition and processing of ballot images (top and bottom) consists of the following steps:

1. The FPGA chip detects the presence of a paper ballot and acquires a ballot image if no transport errors are detected (paper jams, etc.).
2. The FPGA chip pre-processes ballot images before images of both the top and bottom sides of ballots are posted into the main system memory and the ICE software platform is notified.

3. The ICE software platform processes ballot images by first validating that scanned images are of a valid ballot, and, if enabled, checking for the presence of secure infrared (IR) paper stock elements.
4. Using the election database, the ICE software platform is initialized to only recognize and process valid ballots for a given polling place.
5. The image processing module within the ICE software platform determines the ballot barcode and verifies (via the election database) if the tabulator should accept the barcode.
6. The election business logic module within the ICE software platform analyzes which voting targets have been filled-in by the voter.
7. Depending on the system's ballot review and second chance voting settings, the ICE software transitions to the next state within the ballot tabulation process. During this entire image analysis process, any ballot processing or voting errors are reported to the voter in order to provide the elector with the opportunity to accept or reject the ballot.
8. Once a ballot has been fully processed and voter intent is determined, the ICE software updates the raw and tabulated results, creates a summary AuditMark[®], scanned ballot images, and an updated log file. All these files are saved on a set of redundant compact flash memory cards within the ICE device.

2.4.2 Ballot Review and Second Chance Voting

The ICE software platform integrates an optional ballot review function. The ballot review feature allows voters to review their selections and change any votes by remarking the ballot. Once a paper ballot is processed, the voting results for a given ballot are displayed on the LCD for verification. The results are presented in rich text format, which allows voters to easily identify any voting errors they may have made, and to verify that the tabulator has correctly identified the selections. The same verification procedure can be performed for an Accessible Voting Session (AVS). The voter can accept or reject the ballot before it is cast.

2.4.3 Accessible Voting and Ballot Marking

The ImageCast[®] Evolution ballot counter also allows a voter to cast a ballot using accessible devices. The tabulator's audio voting capabilities allows voters to listen to, and vote for, any available choice on the ballot. Through the Audio Tactile Device (ATI) connected to the tabulator, the elector listens to an audio voting session consisting of contest and candidate names. The ATI also allows a voter to adjust the volume and speed of audio playback. Furthermore, the ATI provides voters the opportunity to navigate to the next or previous contest/candidate on the ballot. An elector also has the option to receive visual assistance while voting. A nineteen-inch (19") LCD touch-screen display provides visual voting

information, as well as the ability to change the zoom and contrast levels during ballot presentation. As with audio-based voting, electors make selections using an Audio Tactile Device (ATI) connected to the tabulator.

The audio and visual interfaces indicated can be used separately or simultaneously. All voting choices, such as write-in voting and straight party voting, can be made with the ATI. Voters who require alternative input devices do not have to use the ATI. Instead, they can use a sip and puff device or paddle (foot) switches to navigate the ballot and vote during a voting session. Accessible voting sessions begin when the administrator employs the Administrative iButton Security key and initiates a voting session from the Administrative Menu on the device. When prompted, the administrator enters the appropriate ballot ID. The Administrative iButton Security Key can be also be used to cancel a voting session. This may be necessary when a voter needs to restart their voting session to review any applicable instructions. Each voter begins an AVS session by selecting a language. Following this, instructions are provided to orient the user.

Depending on the MBS settings (please refer to *ImageCast[®] Evolution Machine Behavior Settings* document, for more information about MBS options) and license purchased (Please contact a Dominion representative to learn more about licensing options), the system can have dual monitor support feature. The feature enables running standard and accessible voting session in parallel. In other words, the ImageCast Evolution now supports a secondary COTS-based USB 2.0 to VGA monitor on which Accessible Voting Sessions can be run. The secondary monitor and the unit's LCD touchscreen are independent of one another, which allows for two simultaneous procedures to occur. In other words, this dual monitor functionality allows an Accessible Voting Session to occur while the unit is in standard operating mode and scanning paper ballots.



Figure 2-6: The ImageCast[®] Evolution Ballot Counter - Parallel Standard and AVS.

When the voter has made all ballot selections, the ImageCast[®] Evolution will mark the ballot according to the selections the voter made, rendering the ballot indistinguishable from printed and hand-marked ballots.

After marking is complete, the ballot is scanned. If the ballot review is enabled, the ballot will either be shown to the voter on the ballot review screen or played back to the voter over the headphones (the method depends on the type of AV session the voter initially selected). The voter then has the opportunity to review his/her selections and either cast or return the ballot.

2.4.4 Using ImageCast[®] Devices with ImageCast[®] X Electronic Mobile Ballots

With the advent of the new ImageCast[®] X ballot marking device, processing of machine-generated ballots has been expanded to the ImageCast[®] Precinct and the ImageCast[®] Evolution. This allows voters to independently verify that their voting intentions are recorded accurately, while providing an alternative option to the ImageCast[®] Central for ballot processing. All ImageCast[®] can automatically distinguish between standard hand-marked ballots and the ImageCast[®] X's machine-generated ballots. No manual intervention is required to switch from scanning one type of ballot to the other, and there is no difference in operation (or in the format of the ballot review) between the two ballot types. When the Electronic Mobile Ballot is inserted into the ImageCast[®] Precinct or ImageCast[®] Evolution, the screen will then display a complete listing of all contests contained on the ballot and will indicate the results that would be recorded for each contest once the ballot is cast (ballot review). Depending on the mode of operation, the ballot may be automatically returned to the voter once the review is complete, or the voter might have the option between casting or returning the ballot.

2.5 ImageCast® Central Ballot Counter

The ImageCast® Central Ballot Counter system is a central ballot scan tabulator coupled with custom-made ballot processing application used for accurate, and reliable centralized scanning and counting applications of paper ballots.

The ImageCast® Central is typically utilized to process absentee ballots, but an entire election can be processed through it. Mail-in ballot elections are an example of a type of election in which the ImageCast® Central can be utilized to process the entire population of ballots for that election. The election definition is taken from EMS, using the same data and database that is utilized to program any precinct scanners for a given election.

Multiple ImageCast® Central scanners can be programmed for use in an election. The ImageCast® Central software application is installed and later initialized on a computer attached to the central count scanner.

Ballots are processed through the central scanner(s) in batches based on jurisdictional preferences and requirements. ImageCast® Central can automatically distinguish between standard hand-marked ballots and the ImageCast® X's machine-generated ballots. No manual intervention is required to switch from scanning one type of ballot to the other, and there is no difference in operation (or in the format of the ballot review) between the two ballot types. The ImageCast® Central stores ballot images by scanning batches. The scanned ballot images are migrated to EMS Adjudication and/or EMS RTR through computer networking or by removable media. As with ballot images from any precinct scanners in use for an election, Results Tabulation and Reporting is the portion of EMS that processes the images to provide tabulation and operational reports to the jurisdiction. Batches can be appended, deleted, and processed in a number of ways to suit typical election workflows, intake of ballots before, during, and after Election Day, jurisdiction requirements surrounding absentee ballot tabulation, and Canvassing needs.

NOTE: Optionally, results can be processed by the EMS Adjudication system prior to sending to EMS RTR.

Central scanning system hardware consists of a combination of two COTS devices used together to provide the required ballot scanning processing functionality:

- Scanner: Provides accurate ballot scanning and image transfers to the local ImageCast® Central Workstation.

- ImageCast[®] Central Workstation PC: Ballot image and election rules processing and results transferring to the EMS Datacenter. The ImageCast[®] Central Workstation is a Dominion pre-approved PC workstation hardware which executes the image processing and election rules software application.

Five scanners are available for use with Democracy Suite[®]:

- Canon imageFORMULA DR-G1130
- Canon imageFORMULA DR-M160II
- Canon imageFORMULA DR-M260
- Canon imageFORMULA DR-X10C
- InterScan HiPro

When using the scanners, the following commercially available software applications and tools are used in order to provide the required ballot scanning processing functionality:

- OpenSSL: FIPS-compliant security library
- TWAIN: communications protocol and API for digital imaging devices

For more information on procured and unmodified software items, please refer to *2.05 - Democracy Suite[®] ImageCast[®] Central Software Design and Specification*.

2.6 ImageCast[®] Remote

ImageCast[®] Remote software platform utilizes an N-Tier software architecture, which means that the overall system consists of separate client applications, application server components, database components and a central document repository.

The ImageCast[®] Remote application verifies voters session eligibility and then presents the appropriate ballot to the voter. When a voter is satisfied with choices selected, the ImageCast[®] Remote application verifies them and produces an Electronic Mobile Ballot.

The ImageCast[®] Remote application is designed to perform the following functions:

- Ballot marking and printing of electronic mobile ballots (in BMD mode)
- Ballot review and second chance voting

- Accessible voting and ballot marking

The Admin application is used for administering the ImageCast[®] Remote platform. The ImageCast[®] Remote client application is used as a ballot marking device application that enables a voter to select available candidates. The most important part of this application is the presentation tier with its client logic tier, responsible for ballot rules validation as well as generation of PDF representations of ballot selections on the client end. As soon as ballot is presented to a voter systems stops communication with the server and entire voting session is performed on the client end.

2.6.1 Ballot Marking

Marking of the ballot in BMD mode consists of the following actions:

1. The voter authenticates, enabling the appropriate ballot style to be presented to the voter.
2. Voter selects the language from the list of available languages.
3. The ballot is presented to the voter.
4. Voter makes his/her selections.
5. Voter verifies the selections he/she made on the review screen.
6. When satisfied, the voter can then download the ballot in PDF format.
7. The voter will print and return the ballot to the election official in order that the ballot can later be scanned by a central scanner (ImageCast[®] Central).

When the voting process is finished, the voter will end the voting session.

2.6.1.1 Ballot Review and Second Chance Voting

Before the end of each voting session, the voter is presented with the ballot selection review as a summary of selections for all contests available on the ballot. At this point the voter is informed about any warnings and/or errors that may exist. If the voter is satisfied with selections made, he/she can either proceed to the next step or go back and make further modifications to the selection choices.

2.6.1.2 Electronic Mobile Ballot

The Electronic Mobile Ballot is the compact representation of a voter's selection. It consists of three parts:

- Electronic Mobile Ballot header: Contains the general information about elections and ballot such as: official elections name and date, and ballot style

- QR Barcode encoded voters selection: Machine readable section of the Electronic Mobile Ballot. The Electronic Mobile Ballot can have multiple QR Barcodes depending on the data that needs to be encoded (number of available contests, candidates and write-ins). Encoded data is encrypted and signed in order to prevent tampering of user selection and eliminate the possibility of error during the ballot scanning process.
- Human readable voter selection. Used for audit purposes.

2.6.1.3 Accessible Voting

The ImageCast[®]emote product addresses requirements of accessible voters. Voters are enabled to securely receive and mark their ballot privately and independently using their own personal computers or mobile devices, combined with browser-enabled assistive technologies. Ballots are designed for easy navigation within each contest being voted, indicating clearly how to mark the ballot, as well as the status including feedback regarding the remaining selections eligible to be made in the contest. In addition, voters are provided with navigation aids enabling them to easily move from one ballot contest to another. At any time during voting the voter is able to change their ballot selections, and free to navigate between individual contests.

The ImageCast[®]emote application has been built with the needs of accessible voters as a focus. This includes voters with visual impairments, hearing challenges, and other physical limitations. Accessibility functionality has been built directly into the Dominion Voting solution, created using standardized HTML and JavaScript to meet or exceed WCAG 2.0 Level AA standards and to provide compatibility with market leading browser-based solutions such as screen readers.

Dominion Systems Logic and Accuracy testing includes testing of accessibility features, ensuring the voting solution will perform as expected and as defined by the Election Officials.

2.7 ImageCast[®] X

The ImageCast[®] X consists exclusively of COTS available hardware and operating system, while the applications installed on top customize its behavior to turn it into a Ballot Marking Device (BMD) or a Direct-Recording Electronic (DRE) device with or without a Voter Verifiable Paper Audit Trail (VVPAT).

ImageCast[®] X application is the application that verifies voter's session eligibility, using the smart card and then presents the appropriate ballot to the voter. When a voter is satisfied with choices selected, ImageCast[®] X application verifies them and produces an Electronic Mobile Ballot or stores the votes onto a memory device.

The ImageCast[®] X is designed to perform the following functions:

- Ballot marking and printing of electronic mobile ballots (in BMD mode)
- Ballot review and second chance voting
- Accessible voting and ballot marking
- Saving voting results (in DRE mode)
- Printing votes on a voter verifiable paper audit trail device (when VVPAT is in use)

Before any of these functions can take place, the device goes through a startup procedure that initializes all of the hardware, software modules and all external election files. The startup process consists of the following steps:

- Installation of ICX.apk application on an android device
- Starting ICX client application on tablet or aValue device
- Loading of election files generated by EMS. Election files define if the device will work in one of the following modes:
 - DRE (direct-recording electronic) mode. DRE mode can be configured to work with or without a VVPAT device.
 - BMD (ballot marking device) mode
- Opening poll
- Entering application mode where AVS can be either enabled or disabled

2.7.1 Ballot Marking - BMD Mode

Marking of the ballot in BMD mode consists of the following actions:

1. Poll worker identifies the voter

2. Poll worker issues a Smart Card with the appropriate ballot style for the voter
3. Voter initiates his/her voting session by inserting the smart card into a smart card reader
4. Voter selects the language from the list of available languages
5. The ballot is presented to the voter
6. Voter makes his/her selections
7. Voter verifies the selections he/she made on the review screen
8. When satisfied, the voter can then print the ballot on the attached BMD printer
9. To finish the voting process, the voter has to either feed the ballot into a precinct scanner (ImageCast[®] Precinct or ImageCast[®] Evolution) or cast the ballot into a ballot box in order to be scanned later by a central scanner (ImageCast[®] Central).

When the voting process is finished, the poll worker needs to close the poll.

2.7.1.1 Electronic Mobile Ballot

Electronic Mobile Ballot is the compact representation of a voter's selection. It consists of three parts:

- Electronic Mobile Ballot header: Contains the general information about elections and ballot such as: official elections name and date, and ballot style
- QR Barcode encoded voters selection: Machine readable section of Electronic mobile ballot. Electronic mobile ballot can have multiple QR Barcodes depending of data that need to be encoded (number of available contests, candidates and write-ins). Encoded data is encrypted and signed in order to prevent tampering of user selection and eliminate possibility of error during ballot scanning process

- Human readable voter selection. Used for audit process.

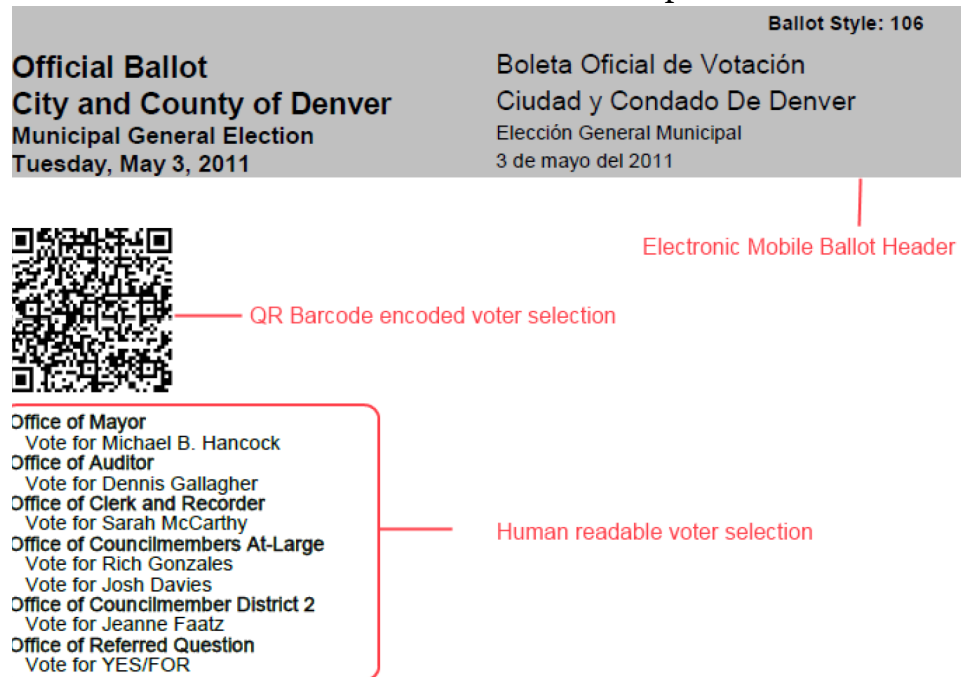

Figure 2-7: Electronic Mobile Ballot

2.7.2 Ballot Marking - DRE Mode

Marking of the ballot in DRE mode consists of the following actions:

1. Poll worker identifies the voter
2. Poll worker issues a Smart Card with the appropriate ballot style for the voter
3. Voter initiates his/her voting session by inserting the smart card into a smart card reader
4. Voter selects the language from the list of available languages
5. The ballot is presented to the voter
6. Voter makes his/her selections
7. Voter verifies the selections he/she made on the review screen
8. When satisfied, the voter can select to proceed to the next step, which can be one of the following:
 - DRE w/o VVPAT - The vote is stored onto a memory device(s) - ballot is cast.

- DRE w/ VVPAT - Voter must review the ballot once more on a VVPAT device before the vote is stored onto a memory device(s). In this mode, the voter has one more chance to change their mind and go back to the ballot, before the ballot is cast.

9. The voting process is finished

When the voting process is finished, the poll worker needs to close the poll.

2.7.2.1 VVPAT Ballot

VVPAT ballot is a compact representation of a voter's selection. It consists of two parts:

- QR Barcode encoded voters selection, machine readable part of VVPAT ballot. The size of QRBarcode depends on data that need to be encoded (number of available contests, candidates and write-ins).
- Human readable voter selection.

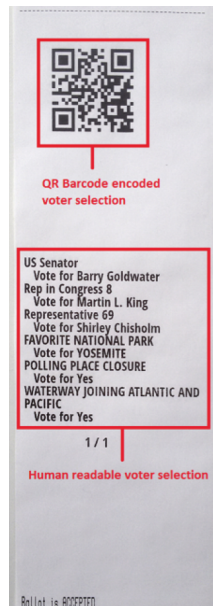

Figure 2-8: VVPAT ballot

2.7.3 Ballot Review and Second Chance Voting

Before the end of each voting session, the voter is presented with ballot selection review as summary of selections for all contests available on ballot. At this point the voter is informed about any warnings and/or errors that may exist. If the voter is satisfied with selections made, he/she can either proceed to the next step or go back and make further modifications to the selections made.

2.7.4 AVS Voting Session

ImageCast[®] X platform also allows a voter to cast a ballot using accessible devices.

AVS voting session is supported using Tecla Shield of the shelf component as well as Audio Tactile Interface (ATI) device. These devices support the following accessible accessories:

- Paddle (foot) switches
- Sip n Puff
- Four position switches (Tecla only)

Tecla shield device allows simultaneous connection of Four position switch and Paddles or Sip N Puff. Paddles and Sip N Puff devices cannot be connected at the same time.

AVS voting session allows disabled voter to navigate to the next contest/candidate on the ballot and make his/her selection. An elector also has the option to receive visual assistance while voting. A touch-screen display provides visual voting information, as well as the ability to change:

- AVS session language
- The zoom levels/text size of presented ballot
- The contrast levels of presented ballot
- Adjust the volume of audio playback

The audio and visual interfaces indicated can be used separately or simultaneously. Accessible voting sessions begins when the voter or poll worker swipes the smart card with valid voting session. The next step is selection of session language and AVS mode/device. Voter has four available options:

- Paddles
- Sip n Puff
- 4 direction switch
- Audio only

After this point voter can complete the process of making candidates selection. Once voter completes the process of candidate selection he is presented with ballot review screen and the whole selection is played back to the voter over the headphones. At this point voter has the opportunity to review his/her selections and either cast/print electronic mobile ballot or return the ballot. Disabled voter may need poll workers assistance in process of storing printed Electronic Mobile Ballot to secured ballot box.

2.8 AuditMark®

When an ImageCast® scanner scans a ballot, it checks to ensure that the ballot is readable and valid prior to examining voter marks and tabulating them. The tabulation is stored in a cast vote record along with an image of the ballot that has been scanned. The tabulation result is presented in a human-readable format, which is appended to the scanned image. This appended information comprises the AuditMark®. The AuditMark® provides the user with the scan results for each contest. These results display the votes the scanner recorded for candidates or measures within a contest.

The AuditMark® can assist in verifying the election at several areas. These areas are: pre-election logic and accuracy testing, recount, canvass, and small batch audits (also known as risk-limiting audits). During pre-election logic and accuracy testing (pre-LAT), a jurisdiction can sample the scan images and AuditMark® from several scanners to ensure that the scanner is properly imaging the ballot. Stray lines or marks on the scan image, images showing foreign materials (specks on the image), incorrect results relative to the pre-LAT vote pattern can be observed and corrected by use of the scan image and AuditMark® during the pre-LAT process.

Once results are available from Election Day, jurisdictions can commence the canvass process. For example, if an election contest leads to a recount, the AuditMark® and scan image can provide additional confirmation regarding how the scanners read voter marks. This capability is invaluable because the canvass and recount Boards may view a voter mark differently. The AuditMark® and scan image allow the Board members to “see” what the scanner viewed and how it interpreted that voter mark. This information is only available from the ImageCast® family of scan voting machines. The EMS Adjudication system also utilizes an AuditMark®, appended to the original, to show the results of a ballot adjudication.

2.9 Democracy Suite® Logical Deployment View

The logical view of the system presented in Figure 2-2 makes it easy to identify basic system components without taking the physical deployment scenarios into account. This view is useful for understanding which generic components are needed to establish an election event system based on the Democracy Suite® platform.

At the core of the system, the EMS Data Center server modules are responsible for orchestrating the election activities and for storing election domain data. The EMS client applications communicate with the EMS Data Center back-end system

(EMS Application, Database, NAS server and Election Device Management modules) using the TCP/IP protocol or pipes (local level inter-process communication).

For usual election project related activities, main client applications used are: Election Event Designer (EED), Results Tally and Reporting (RTR) and ImageCast[®] Voter Activation application. The EMS platform can also include several optional components: Election Data Translator (EDT), Audio Studio (AS), Adjudication (ADJ), AIMS Data Translator (AIMS DT), Mobile Ballot Production (MBP), Results Transfer Manager (RTM), WinEDS Importer and Election Data Exchange Station (EDES). All EMS client applications that access and make use of the EMS Database on the EMS Data Center allow only authenticated and authorized user access. EMS server components enforce authenticated and authorized user access.

The primary function of the EMS EED client application is to provide accurate, efficient, and secure procedures for defining elections. In contrast, the primary function of the EMS RTR client application is to collect, process, validate, and report election results in an accurate, efficient, and secure manner.

Both applications contain their own set of defined inputs and outputs.

ImageCast[®] Voter Activation application is a polling location tool that allows poll workers to program smart cards for voters in order to activate voting sessions on ImageCast[®] X.

For the EMS EED client application, inputs represent a variety of election domain related information which is either, entered manually by operators, imported via EMS EDT or from external systems in a predefined XML format, or imported from previous election projects. Outputs represent a variety of files, including ballots (paper, electronic and AVS), definition reports, and election definition files required to properly program the ImageCast[®] devices.

For the EMS RTR application inputs are encrypted and signed election result files and scanned ballot images produced by the ImageCast[®] devices. Outputs from the EMS RTR client application are a variety of election result reports in different file formats, as well as auditing information.

The EMS Adjudication application communicates with EMS APPS application, via appropriate Adjudication and EMS APP services, to get the requested signed ballot images, and vote records for those ballot images from the EMS Cast Vote Record (CVR) data store on the EMS server. The selection of ballot images and voter records provided to EMS Adjudication are determined by the filtering criteria set in the EMS Adjudication application. Outputs from the EMS

Adjudication are modified vote records and ballot images containing both original ImageCast audit mark, as well as the appended audit marks from Adjudication, as well as summary and activity reports.

To ensure the ImageCast® devices operate properly, the EMS platform produces memory packs with election event related definitions and security keys. Within the Democracy Suite® platform, these files are either defined as election definition files, a database or device configuration (DCF for ICC and ICP) and behavioral setting files (MBS for ICE). The first set (election definition files and database) defines election rules and ballots to be processed by a particular instance of the ImageCast® device, while the second set (DCF and MBS) contains various device specific configurations and behavioral settings. In addition, EMS issues appropriate user credentials by programming security keys.

The Democracy Suite® election platform supports all ImageCast® series tabulators: ImageCast® Precinct (ICP), ImageCast® Evolution (ICE), ImageCast® Central (ICC) and ImageCast® X (ICX). These devices are either used at polling places (ICP, ICE and ICX) for election day voting, or at central count locations (ICC) for vote-by-mail, absentee, or early voting.

2.10 Democracy Suite® Physical Deployment View

The EMS platform is available in two hardware configurations:

- **EMS Express:** All EMS software components are installed on a workstation type PC, that may be connected to one or more additional workstations (EMS EEE, RTR, ADJ and/or ICC) via a network switch. In this configuration, the workstation acts as an EMS server and is configured for redundancy and adequate performance.
- **EMS Standard:** In addition to the UPS and LAN network switch devices, the EMS server components are installed on a single physical sever, while the EMS client components are installed on one or more physical PCs. All system components are interconnected in a client-server local LAN environment.

For jurisdictions that use transmission functionality, EMS configurations are expanded to include the ImageCast® Listener, and where applicable, a remote access server (RAS). To mitigate the possible risks related to system exposure via a public telecommunication network (Wireless and/or Dial-Up), these configurations implement several security measures. ImageCast® Listener services run on a separate server with dual network cards, and remote access server is installed as a first security layer for Dial-Up transmissions. Both EMS Express and EMS Standard configurations with ImageCast® Listener/RAS, include a firewall appliance to control the access to the network.

For detailed information on EMS configurations, please see Chapter 3

CHAPTER 3: OPERATIONAL ENVIRONMENT

3.1 Democracy Suite[®] EMS Operational Environment

The Democracy Suite[®] EMS platform consists of multiple components. The list below provides names and abbreviations for of all components. The descriptions on what each of the components is used for, please see Section 2.2.

- EMS Election Event Designer[™] (EED): End-user application
- EMS Results Tally and Reporting[™] (RTR): End-user application
- Adjudication (ADJ): End-user application
- EMS Audio Studio (AS): End-user application
- EMS File System Service (FSS): End-user application
- ImageCast[®] Voter Activation (ICVA): End-user application
- EMS Election Data Translator (EDT): End-user application
- EMS Result Transfer Manager (RTM): End-user application
- EMS Election Data Exchange Station (EDES): End-user application
- EMS Application Server (APPS): Backend application
- EMS Service (EMSService): Backend application
- EMS Adjudication Services: Backend application
- EMS Network Attached Storage (NAS): Backend file repository component
- EMS Database Server (DB): Backend database repository component
- EMS Data Center Manager (DCM): Backend configuration component
- ImageCast[®] Listener (Listener Service): Backend application
- EMS Shell Service (Web Service): Backend application
- EMS AIMS Data Translator (AIMS DT): End-user application
- DVS Transmission Dashboard (Windows Application): End-user application
- Cartridge Manager (Windows Service): Backend application
- Mobile Ballot Production (MBP): End-user application
- EMSLogger: End-user application

Depending on the deployment scenario, the Democracy Suite EMS system requirements can vary. As a result of the system's modularized architecture, system requirements can be defined for each component. Consequently, the Democracy Suite[®] EMS platform can be deployed in one of the following hardware configurations:

- **EMS Express:** All EMS software components are installed on a workstation type PC, that may be connected to one or more additional workstations (EMS EED, RTR, ADJ and/or ICC) via a network switch. In this configuration, the workstation acts as an EMS server and is configured for redundancy and adequate performance.
- **EMS Standard:** EMS server components are installed on a single physical sever hosting backend applications (DB, NAS, APPS, EMSService and other services required for Adjudication and Listener, if applicable). The EMS client components (EED, RTR, ADJ, AS, FSS, EDT, RTM) are installed on one or more physical PCs. All system components are interconnected in a client-server local area network environment.

NOTE: RTM and RTR cannot exist on the same workstation.

- **EMS Standard or EMS Express with ImageCast[®] Listener (Wireless/Dial-up):** For jurisdictions that use transmission functionality, EMS configurations are expanded to include the ImageCast[®] Listener, and where dial-up is required, a remote access server (RAS). These configurations allow for secured network deployment exposed to public telecommunication networks in order to receive transmissions from the ICP and/or ICE devices. The backend applications (Database Server, NAS, APPS, EMSService and other services required for Adjudication and Listener such as EMS Adjudication Services, Cartridge Manager, EMS Shell Service) run on a physically separate set of servers with dual network cards. In addition, both EMS Express and EMS Standard configurations with ImageCast[®] Listener/RAS, include a firewall appliance to control the access to the network. The remote access server (RAS) is installed as a first security layer for Dial-Up transmissions. The ImageCast[®] Listener Server runs the ImageCast[®] Listener service, which grants the ICP and/or ICE access to upload the results in the system. The end-user applications (EED, RTR, AS, ADJ, FSS, EDT, RTM, DVS Transmission Dashboard) are executed from computers connected to the local network.

3.1.1 EMS Hardware Configuration

3.1.1.1 EMS Express Hardware Configuration

The EMS Express configuration is a flexible configuration ranging from one all-in-one machine (where both its server and client components run on a single desktop) to server/client configuration connected via network switch. In either of the variants described above, the EMS Express configuration hardware is comprised out of PC workstations rather than server machines. The workstations acting as EMS servers have the built-in redundancy and are running Windows 10 and SQL Express. At any one time there can be up to 10 workstation (EMS, ADJ and/or ICC) connected to the switch. Figure 3-1, illustrates the EMS Express configuration without the transmission components.

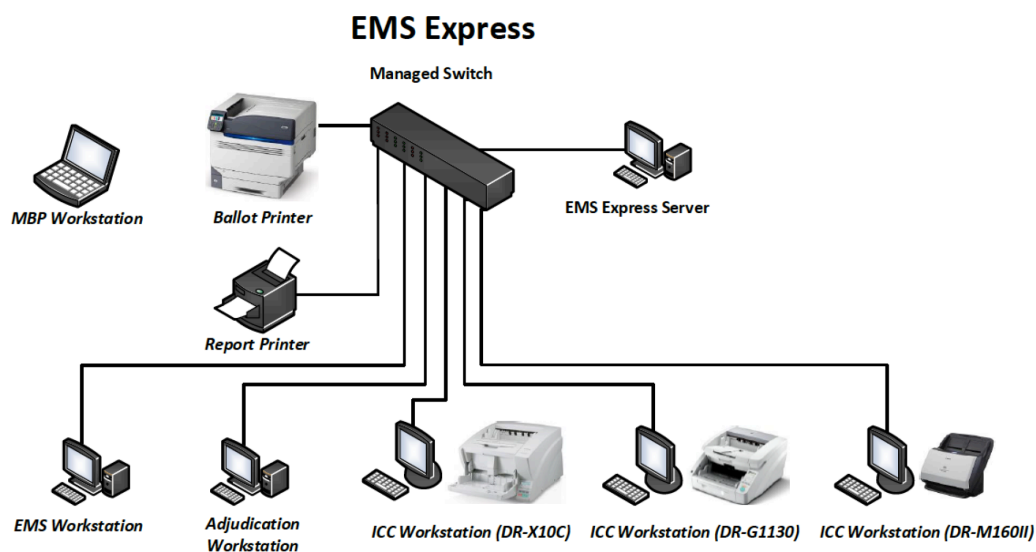

Figure 3-1: The Democracy Suite[®] EMS Express Hardware Configuration.

EMS Express Server Hardware Configuration:

- Workstation class computer
- Dual quad core CPU (Intel i5 series)
- 16 GB RAM minimum
- Dual 500 GB in RAID 1 mode (mirror)
- DVD reader
- Smart UPS
- USB Compact Flash card reader
- USB iButton Security Key reader
- 19" or higher monitor for desktop PCs
- Keyboard and mouse

- Headset or headphones with microphone

EMS Express Client Hardware Configuration:

- Workstation class computer
- Single or Dual quad core CPU (Intel i5 series)
- 8 GB RAM minimum
- 500 GB HDD minimum
- DVD reader
- USB Compact Flash card reader
- USB iButton Security Key reader
- 19” or higher monitor for desktop PCs
- Keyboard and mouse
- Headset or headphones with microphone

3.1.1.2 EMS Standard Hardware Configuration

The EMS Standard hardware configuration provides a client-server local LAN deployment environment. This hardware configuration separates client and server system components by utilizing a single physical server device to run all EMS server components. Client PC computers running EMS client applications are interconnected with the back-end server component through the gigabit LAN network which utilizes the smart network switch. The client applications can also be run on the EMS server computer.

Figure 3-2, illustrates the EMS Standard configuration without the transmission components.

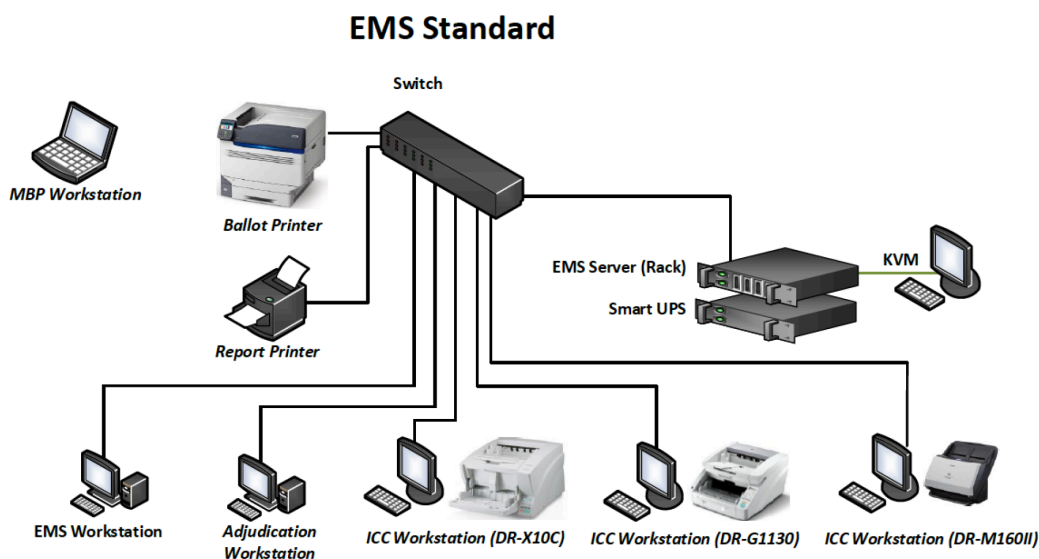

Figure 3-2: The Democracy Suite[®] EMS Standard Configuration.

EMS Standard Server Hardware Configuration:

- Server class computer
 - Dual quad core CPU (Intel Xeon E5 series)
 - 32 GB RAM minimum
 - Dual 1 TB in RAID 1 mode, and 4x 1 TB in RAID 10 mode
 - Dual power supply
 - DVD reader
 - Smart UPS
 - 19” or higher monitor for desktop PCs
 - Keyboard and mouse
- **EMS Standard Client Hardware Configuration:**
- Workstation class computer
 - Single or Dual quad core CPU (Intel i5 series)
 - 8 GB RAM minimum
 - 500 GB HDD minimum
 - DVD reader
 - USB Compact Flash card reader
 - USB iButton Security Key reader
 - 19” or higher monitor for desktop PCs
 - Keyboard and mouse
 - Headset or headphones with microphone

3.1.2 EMS Software Configuration**3.1.2.1 EMS Express Software Configuration****EMS Express Server Software Configuration:**

- Microsoft Windows 10 Pro
 - .NET Framework 2.0
 - .NET Framework 3.5
 - .NET Framework 4.7.2
 - Windows Defender
 - Internet Information Services (IIS)
 - Message Queue Service (MSMQ)

- Microsoft SQL Server 2016 Standard, SP 1
- SQL Server Management Studio
- Microsoft Visual C++ 2013 Redistributable
- Microsoft Visual C++ 2015 Redistributable
- Adobe Reader DC
- Dell drivers
- Fonts
 - Arial Narrow (2.37a)
- **Optional:**
 - Cepstral Voices 6.2.3
 - iButton Driver
 - Microsoft Access Database Engine
 - Open XML SDK 2.0 for Microsoft Office
 - Ballot printer drivers
 - Report printer drivers
 - UPS drivers
 - RAID utility
 - Windows Defender

EMS Express Client Role Software Configuration:

- Microsoft Windows 10 Pro
 - .NET Framework 3.5
 - Windows Defender
 - Internet Information Services (IIS)
 - Message Queue Service (MSMQ)
- Microsoft Visual C++ 2013 Redistributable
- Microsoft Visual C++ 2015 Redistributable
- iButton Driver
- Adobe Reader DC
- Dell drivers – Optional:
 - Microsoft Access Database Engine
 - Open XML SDK 2.0 for Microsoft Office
 - Report printer drivers

- Ballot printer drivers
- UPS drivers

3.1.2.2 EMS Standard Software Configuration

EMS Standard Server Software Configuration:

- Microsoft Windows Server 2016
 - .NET Framework 2.0
 - .NET Framework 3.5
 - .NET Framework 4.7.2
 - DNS Service
 - DHCP Service
 - Internet Information Services (IIS)
 - Message Queue Service (MSMQ)
- Microsoft SQL Server 2016 Standard, SP 1
- SQL Server Management Studio
- Microsoft Visual C++ 2013 Redistributable
- Microsoft Visual C++ 2015 Redistributable
- Adobe Reader DC
- Dell drivers
- Fonts
 - Arial Narrow (2.37a)
- **Optional:**
 - Cepstral Voices 6.2.3
 - Ballot printer drivers
 - Report printer drivers
 - UPS drivers
 - RAID utility
 - Windows Defender

EMS Standard Client Software Configuration:

- Microsoft Windows 10 Pro
 - .NET Framework 2.0
 - .NET Framework 3.5
 - Windows Defender

- Internet Information Services (IIS)
- Message Queue Service (MSMQ)
- Microsoft Visual C++ 2013 Redistributable
- Microsoft Visual C++ 2015 Redistributable
- iButton Driver
- Adobe Reader DC
- Dell drivers
- Optional:
 - Microsoft Access Database Engine
 - Open XML SDK 2.0 for Microsoft Office
 - Report printer drivers
 - Ballot printer drivers
 - UPS drivers

3.2 ImageCast[®] Precinct Operational Environment

The ImageCast[®] Precinct system is a precinct optical scan ballot tabulator designed to scan marked paper ballots, interpret voter marks on the paper ballot, communicate these interpretations back to the voter, and upon acceptance by the voter, deposit the ballots into the secure ballot box. The ImageCast Precinct also provides enhanced accessibility voting through an optional ATI unit, which is tethered to the ImageCast[®] Precinct.

3.2.1 Functional Elements

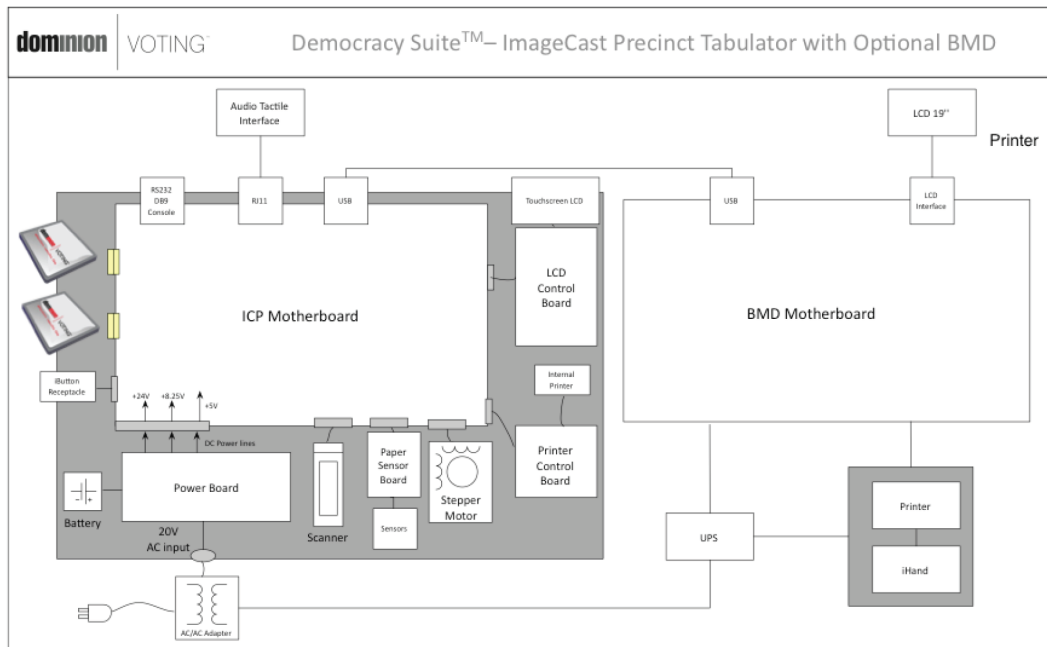

Figure 3-3: The ImageCast® Precinct Functional Block Diagram (with optional BMD).

The ImageCast® Precinct's major system elements are:

- Operating System: uClinux
- Motherboard - MCF5249 ColdFire Processor-based circuit that provides:
 - Overall control of all system elements
 - Main connectivity point for all other subsystems
 - 32MB of SDRAM (MT48LC16M16A2), 4MB of onboard Flash (M29W320DB), Xilinx CPLD (system glue logic) and other electronic circuitry necessary for control and connectivity of other ImageCast® subsystems.
- Removable Memory Modules: Two memory packs (internal type II Compact Flash memory cards). CompactFlash is high capacity, solid-state flash-based memory that electrically complies with the Personal Computer Memory Card.
- Optional Modem: Part of ImageCast® Precinct motherboard and provides connectivity for standard Socket Modems (includes built-in universal modem socket to support standard embedded Socket Modem modules).
- Scanners: ImageCast® Precinct uses two optical imaging scanners (ON Semiconductor NOM02A4DR17G 200 DPI Contact Image Sensors) for creating a duplex scanned image of each side of the ballot.

- **Display:** ImageCast[®] Precinct uses EDT Corp's 5.7" LCD touch panel EW32FKBNW*Fo(1/4 VGA) controlled by the LCD-Printer Controller Board (based on S1D13700Fo1 Embedded Memory Graphics LCD Controller).
- **Internal Printer:** Thermal print mechanism for generating, starting, and ending reports. Internal Printer Circuitry includes a LCD-Printer Control Board and an integrated printer (thermal line dot printer with resolution of 6 dots/mm). The LCD-Printer Control Board, which consists of a printer controller (PT800P01) and step motor driver, is designed to provide logical control of the printer.
- **iButton:** ImageCast[®] Precinct's administrative iButton security key interface uses the iButton reader (physically attached to the top of the unit and electrically connected to the motherboard) and the Dallas DS1963S iButton security key to provide a variety of verification and security tasks, such as access control, data confidentiality, and integrity functions.
- **Paper Feed Mechanism:** Motorized mechanism for detecting and moving the paper ballot within the tabulator. It is intended for handling ballots 8.5 inches (216 mm) wide by a variable length between 11" and 22". The paper feed mechanism is physically capable of moving the ballot paper forward into the machine, across image sensors, enabling complete image capture of both sides of the ballot.
- **Ballot Diverter:** Device that is physically able to divert ballots into a separate compartment within the ballot box.
- **Power Supply Module:** Module for converting 20V AC line input to all voltages needed by the system. This module includes an intelligent battery charger.
- **Battery Pack:** Internal battery pack capable of powering the system for at least three hours. The battery type is Li-Ion.
- **Ballot box:** Contains several key elements such as multiple storage compartments (main, diverted, auxiliary), multiple locks and doors, and access control monitoring. It is an integrated component of the voting system, and it includes security arrangements to prevent unauthorized access to the tabulation component and a locking access door for all ballot locations.
- **Packaging:** The unit is stored and transported in a cardboard box with internal foam for vibration and impact protection.

3.2.2 Safety and Compliance

The ImageCast[®] Precinct system complies with the following standards:

- Safety - UL 60950-1

- Electrical Power Disturbance - IEC 61000-4-11 (1994-06) standard (Voltage dips, short interruptions, and voltage variations immunity)
- Electrical Fast Transient - IEC 61000-4-4 (1995-01) standard (Electrical fast transient/burst immunity)
- Lightning Surge - IEC 61000-4-5 (1995-02) standard (Surge immunity test)
- Electrostatic Disruption - IEC 61000-4-2 (1995-01) standard (Electrostatic discharge immunity)
- Electromagnetic Radiation - FCC Part 15 Class B requirement
- Electromagnetic Susceptibility - IEC 61000-4-3 (1996) standard (Radiated, radio frequency, electromagnetic field immunity)
- Conducted RF Immunity - IEC 61000-4-6 (1996-04) standard (Immunity to conducted disturbances induced by radio-frequency fields)
- Magnetic Fields RF Immunity - IEC 61000-4-8 (1993-06) standard (Power frequency magnetic field immunity)

3.2.3 Environmental

The ImageCast[®] Precinct system complies with the MIL-STD-810-D standard, Method 502.2 and Method 501.2, with test conditions described in VVSG Volume II § 4.7.1.

The ImageCast[®] Precinct system complies with the following standards:

- MIL-STD-810D, Method 516.3, Procedure VI (drop test)
- MIL-STD-810D, Method 514.3, Category 1- Basic Transportation, Common Carrier (vibration test)
- MIL-STD-810D, Method 502.2, Procedure I-Storage (high and low temperature test; 4 hours at -4°F and 4 hours at $+140^{\circ}\text{F}$)
- MIL-STD-810D, Method 507, (Humidity test) as specified in VVSG Volume II paragraph 4.6.1
- MIL-STD-810D, Method 502.2 and Method 501.2 - Temperature and Power variation test

3.2.4 Data Network

The Democracy Suite[®] platform in its EMS Express and EMS Standard configurations does not use public communication networks for its operation. However, the EMS Standard and Express with /ImageCast[®] Listener allow the ImageCast[®] Precinct and ImageCast[®] Evolution to use public telecommunications networks to send the results to the EMS Data Center in a secure manner.

3.2.5 Input Power

The ImageCast® Precinct uses a COTS UL approved AC adapter as a main power source that provides 20V AC power to the internal Power Module. The AC adapter requires input voltage to be 120V 60Hz.

3.2.6 Physical Access Control

3.2.6.1 Door Coverage

Each ImageCast® Precinct door is secured with the appropriate locking mechanism.

3.2.6.2 Security

The ImageCast® Precinct is equipped with an iButton security key reader. This reader, in combination with the iButton security key, performs a variety of verification and security tasks pertaining to access control, data confidentiality, and integrity functions. The content of the iButton security key is protected by the user's password which must be entered each time the iButton is used. Every result file created by the ImageCast® Precinct is protected by signing and encryption using the Secure Hash Algorithm (SHA) and Advanced Encrypted Standard (AES). The algorithm can be protected by the security hardware machine or the open SSL FIPS certified library.

A detailed hardware description is provided in the *2.04 - Democracy Suite® ImageCast® Precinct System Hardware Specification*.

3.3 ImageCast® Evolution Operational Environment

The ImageCast® Evolution system is a precinct optical scan ballot tabulator designed to scan marked paper ballots, interpret voter marks on a paper ballot, communicate these interpretations back to the voter, and upon the voter's acceptance, securely deposit the ballots into the secure ballot box. The ImageCast® Evolution also provides enhanced accessibility voting, accomplished via an ATI unit, LCD screen and ballot printer.

3.3.1 Functional Elements

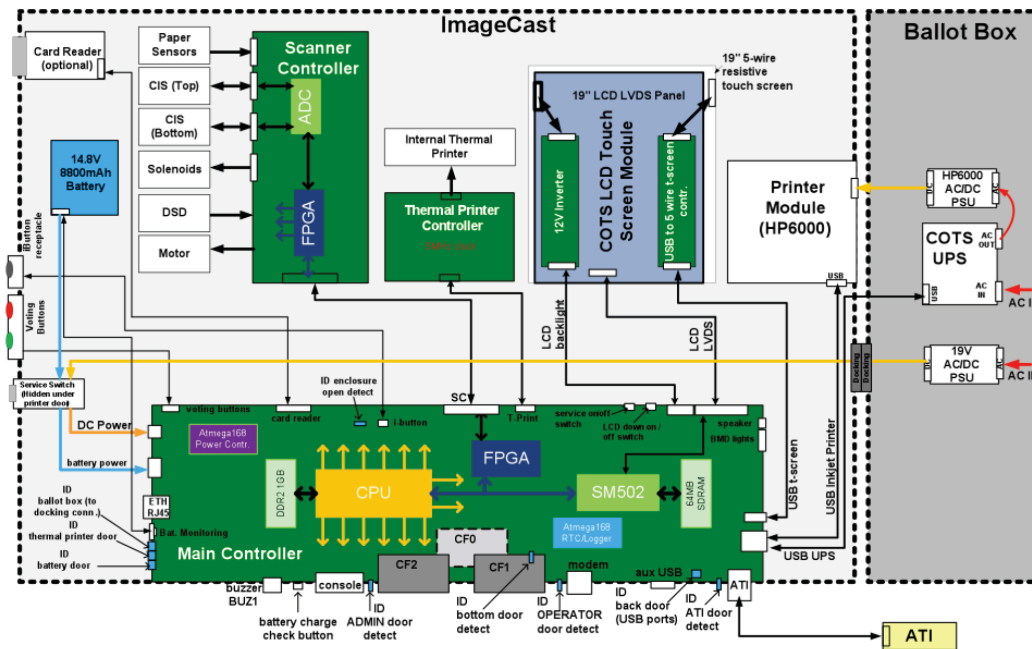

Figure 3-4: The ImageCast[®] Evolution Functional Block Diagram.

The ImageCast[®] Evolution major system elements are:

- Operating System: Linux 2.6.30
- Main Controller: MPC8347E PowerPC Processor-based circuit that provides:
 - Overall control of all system elements
 - Main connectivity point for all other subsystems
 - 1 GB of DDR2 DRAM, 4MB of onboard Flash, Xilinx FPGA (scan and print transport control, additional communication interfaces and system glue logic) and other electronic circuitry necessary for control of, and connectivity to, other ImageCast[®] sub-systems.
- Removable Memory Modules: Two memory packs (internal type II Compact Flash memory cards). CompactFlash is high-capacity solid-state flash-based memory that electronically complies with the Personal Computer Memory Card International Association ATA standards and supports a True IDE Mode that is electronically compatible with an IDE disk drive. The ImageCast[®] Evolution uses standard CF modules, like SanDisk Ultra II or similar, as Primary and Administration modules. Both modules have a Mean Time Before Failure (MTBF) greater than 1,000,000 hours and over 100,000 erase/program cycles.

- **Scanner Controller:** Part of the ImageCast[®] Evolution system that represents a centralized place for paper feed mechanism control which connects optical, mechanical, and electrical peripherals that are used in the process of ballot scanning and printing. The main control logic for the ballot scanning process is located inside the Main Controller FPGA which feeds the Scanner Controller with commands. Based on these commands, the Scanner Controller controls and monitors scanning peripherals. It also processes signals from these peripherals and passes them to the Main Controller FPGA.
- **Scanners:** ImageCast[®] Evolution uses two optical imaging scanners (ON Semi's dual output analog 200 DPI Contact Image Scanners) to create a duplexed scanned image of each side of the ballot.
- **Display:** 19" backlit liquid crystal display with integrated touch screen functionality. that is used for displaying software-controlled messages to voters and election officials. The ImageCast[®] Evolution uses a custom assembled 19" LCD Touch screen module that contains the following electrical subsystems:
 - M190EG01 LCD panel with 5 wire touch screen 97M190E1NoF-06
 - LCD Inverter 32AQF132V3F
 - Touchpanel Controller 89C150UAoF
- **Graphic Chip-SM502** located on the Main Controller: Responsible for driving the 19" LCD.
- **Internal Printer:** Thermal print mechanism for generating, starting, and ending reports. Internal Printer Circuitry includes a Printer Control Board and an integrated printer LTPC235 (off-the-shelf thermal line dot printer with a resolution of 6 dots/mm). The Printer Control Board provides logical control of the printer and consists of the printer controller, PT800P01, and a step motor driver.
- **iButton:** ImageCast[®] Evolution 's iButton security key interface uses an iButton reader (physically attached to the side of the unit and electrically connected to the motherboard) and an iButton security key (Dallas DS1963S SHA-1) to provide a variety of verification and security tasks related to access control, data confidentiality, and integrity functions.
- **Paper Feed Mechanism:** Motorized mechanism that detects and moves the paper ballot within the tabulator. It is intended for handling ballots 8.5 inches (216 mm) wide by a variable length (minimum 11", maximum 22"). The paper feed mechanism that is able to move the ballot paper forward into the machine and across image sensors and enable complete images to be captured of both sides of the ballot. The Paper Feed Mechanism can also transport paper during ballot printing.

- **Ballot Diverter:** Device that is physically able to divert ballots into a separate compartment within the ballot box.
- **External AC/DC Power Adapter:** External Power Supply with all required safety and FCC approvals.
- **Battery Pack:** Internal battery pack capable of powering the scanning system for at least three hours. The battery type is Li-Ion. The battery compartment is large and contains inserts that allow it to be adapted to different battery types.
- **Ballot Printer (printer module):** The COTS USB-based printer is part of the accessible voting hardware and is used to print ballots when the voter has finished making their ballot selections.
- **ATI:** Audio Tactile Interface is a handheld device used by a voter during an accessible voting session to navigate and make selections to their ballot.
- **LCD Screen:** As part of the ballot marking capabilities of the ImageCast[®] Evolution platform, a large (19") LCD display is used to preview electronic versions of the ballot used during the accessible voting session. The system allows zoom and contrast control.
- **Ballot box:** Contains several key elements, such as multiple storage compartments (main, diverted, auxiliary), and multiple locks and doors. It is an integrated component of the voting system, with security arrangements to prevent unauthorized access to the tabulation component and has a locking access door for all ballot areas.
- **Packaging:** The unit is stored and transported in a cardboard box packed with foam for vibration and impact protection and ease of use.

3.3.2 Safety and Compliance

The ImageCast[®] Evolution system complies with the following standards:

- Safety - UL 60950-1.
- Electrical Power Disturbance - IEC 61000-4-11 (1994-06) standard (Voltage dips, short interruptions, and voltage variations immunity)
- Electrical Fast Transient - IEC 61000-4-4 (1995-01) standard (Electrical fast transient/burst immunity)
- Lightning Surge - IEC 61000-4-5 (1995-02) standard (Surge immunity test)
- Electrostatic Disruption - IEC 61000-4-2 (1995-01) standard (Electrostatic discharge immunity)
- Electromagnetic Radiation - FCC Part 15 Class B requirement
- Electromagnetic Susceptibility - IEC 61000-4-3 (1996) standard (Radiated, radio frequency, electromagnetic field immunity)
- Conducted RF Immunity - IEC 61000-4-6 (1996-04) standard (Immunity to conducted disturbances induced by radio-frequency fields)
- Magnetic Fields RF Immunity - IEC 61000-4-8 (1993-06) standard (Power frequency magnetic field immunity)

3.3.3 Environmental

The ImageCast[®] Evolution system complies with the MIL-STD-810-D standard, Method 502.2 and Method 501.2, with test conditions described in VVSG Volume II § 4.7.1 (low and high temperature tests). In addition, the ImageCast[®] Evolution system complies with the following standards:

- MIL-STD-810D, Method 516.3, Procedure VI (drop test)
- MIL-STD-810D, Method 514.3, Category 1 - Basic Transportation, Common Carrier (vibration test)
- MIL-STD-810D, Method 502.2, Procedure I-Storage (high and low temperature test; 4 hours at -4°F) and 4 hours at +140°F)
- MIL-STD-810D, Method 507 Humidity test, as specified in VVSG Volume II § 4.6.1.

3.3.4 Data Network

The Democracy Suite[®] platform in its EMS Express and EMS Standard configurations does not use public communication networks for its operation. However, the EMS Standard and Express with /ImageCast[®] Listener allow the ImageCast[®] Precinct and ImageCast[®] Evolution to use public telecommunications networks to send the results to the EMS Data Center in a secure manner.

3.3.5 Input Power

The ImageCast[®] Evolution uses a COTS UL approved FranMar AC Adaptor as a main power source to provide 19V DC power to the ImageCast[®] Evolution internal electronic subsystems. The AC adapter requires an input voltage of 120V 60Hz.

3.3.6 Physical Access Control

3.3.6.1 Door Coverage

Each ImageCast[®] Evolution door is secured with an appropriate locking mechanism.

3.3.6.2 Security

The ImageCast[®] Evolution is equipped with an electronic iButton security key reader. This reader, in combination with the iButton security key, performs a variety of verification and security tasks pertaining to access control, data confidentiality and integrity functions. The content of the iButton security key is protected by the user's password which must be entered each time the key is used. Every result file created by the ImageCast[®] Evolution is protected by signing and encryption using the Secure Hash Algorithm (SHA) and Advanced Encrypted Standard (AES). The algorithm can be protected by the security hardware machine or the open SSL FIPS certified library.

A detailed hardware description is provided in *2.04 - Democracy Suite[®] ImageCast[®] Evolution System Hardware Specification* and *2.04.1 - Democracy Suite[®] ImageCast[®] Evolution System Hardware Characteristics*.

3.4 ImageCast[®] Central Operational Environment

3.4.1 Functional Elements

The ImageCast[®] Central consists of an optical ballot scanner and an attached ballot image and an election rules processing workstation.

The ImageCast[®] Central Scanner uses internal cameras to capture and digitize both sides of a document in a single scan. Depending on the scanner model used, scanner speeds can reach as high as 150 pages per minute (letter size paper).

The ballot image processing station is a COTS PC workstation, connected to the ImageCast[®] Central Scanner via a USB interface. All ImageCast[®] Central Workstations are connected via a Gigabit Ethernet port (through a closed local area network) to the EMS datacenter network. This network stores all results. The ImageCast[®] Central Workstation consists of the following main parts:

- Microsoft Operating System: Windows 10 Pro
- Processor: Intel Core 2 Duo or better
- Memory: 8 GB RAM
- Hard Drive: 500 GB HDD

3.4.2 Scanner Safety and Compliance

3.4.2.1 FCC Compliance

Following Part 15 of FCC rules, this equipment has been tested and found to comply with the limits of a Class B digital device.

For complete safety and compliance information, please read the vendor's original documentation.

3.4.3 Workstation Safety and Compliance

For a detailed list of safety and compliance certifications, please read the PC Workstation safety and compliance reports which are supplied as part of this Technical Data Package.

3.4.4 Environmental

The ImageCast[®] Central Scanner equipment has been designed to operate in a normal office environment. To ensure that the environment complies with the required setup conditions, perform the following:

- Ensure that room housing the scanner is clean, well ventilated, and free of combustible vapors.

- Ensure the minimum clearance on both sides and the rear of the scanner is at least 4" (101.6 mm). Physical Device size is (H x W X D): 14.8" x 20.8" x 22.2".
- Ensure all electrical outlets are properly grounded. Use of a dedicated power line is recommended.
- Place the scanner on a level surface.

For the ImageCast Workstation environmental information, please read the vendor's original documentation.

3.4.5 Data Network

The ImageCast[®] Central Scanner is not connected to any data network directly. However, it is directly connected to the ImageCast[®] Central Workstation.

The ImageCast[®] Central Workstation uses a standard Gigabit Ethernet port to connect to a Local Area Network.

3.4.6 Input Power

Canon scanners require input voltage to be 120-240 V, 50-60 Hz (or 120V, 60Hz depending on the region) and auto-sensing. Power consumption is a maximum of 125 watts.

The interScan HiPro requires input voltage to be 115-240 V, 50-60 Hz. Power consumption is a maximum of 900 watts.

For the ImageCast[®] Central Workstation power input requirements, please read the vendor's original documentation.

3.5 ImageCast[®] Remote Operational Environment

The ImageCast[®] Remote is standalone ballot marking device.

3.5.1 Software Configuration

The application platform used in the ImageCast[®] Remote platform is based on Windows Server 2016 and the development environment is Visual Studio 2015. Users can access the application platform using industry standard web browsers.

3.6 ImageCast[®] X Operational Environment

The ImageCast[®] X is standalone ballot marking or direct-recording electronic device. Voting sessions on the device are activated via Smart Cards that can be programmed by the ImageCast[®] Voter Activation application. The following image, Figure 3-5 to Figure 3-9 illustrates the ImageCast[®] X configuration.



Figure 3-5: Prime



Figure 3-6: Classic



Figure 3-7: Samsung



Figure 3-8: BMD



Figure 3-9: VVPAT

The following table illustrates all ICX configurations, see Table 3-1.

ICX Configurations			
Model	Type	Hardware	Android OS
ICX Advantage	DRE	40" aValue	4.4.4, 5.1.1
ICX Prime	BMD, DRE	21.5" aValue	5.1.1, 8.1
ICX Classic	BMD, DRE	15.6" aValue 21.5" aValue	4.4.4, 8.1
ICX Samsung	BMD, DRE	Samsung Galaxy Tab Pro 12.2 Samsung Galaxy Note Pro 12.2	4.4.2, 5.0.2

Table 3-1: ICX Configurations

3.6.1 Hardware Configuration

The ImageCast[®] X hardware platform consists of following elements:

- Voting terminals:
 - Samsung Galaxy Tab Pro 12.2
 - Samsung Galaxy Note Pro 12.2
 - aValue Classic 15.6"
 - aValue Classic 21.5"
 - aValue Prime 21.5"
- Printer (BMD):
 - HP LaserJet Pro m203dw
 - HP LaserJet Pro m402dn
 - HP LaserJet Pro m402dne
- Printer (DRE w/ VVPAT): KFI VRP3
- Printer (DRE w/o VVPAT): KFI NAUT 324
- PC-Linked Smart Card Reader SDK: Built into aValue devices or attached to Android tablet via LavaLink Adapter
- Smart Cards
- Accessibility components:
 - Audio Tactile Device (ATI) and accessories

- Tecla and accessories (only for Samsung based voting terminals)

The following table illustrates all ICX tabulator specifications, see Table 3-2.

ICX Tabulator Specifications				
	ICX Advantage	ICX Prime	ICX Classic	ICX Samsung
Screen size	21.5"	21.5", 15.6"	12.2"	40"
CPU architecture	X86	X86	ARM	X86
Ram	4GB	2GB	3GB	4GB
Storage	32GB	32GB	32GB	32GB
USB ports	2 x USB 3.1 Standard-A 5 x USB 2.0 Standard-A	1 x USB 2.0 micro-B 5 pin 4 x USB 2.0 type A	1 x USB 2.0 micro-B 5 pin 1 x USB 3.1 micro-B 10 pin	2 x USB 3.1 Standard-A 2 x USB 2.0 Standard-A

Table 3-2: ICX Tabulator Specifications

3.6.2 Software Configuration

- ImageCast[®] X Voting terminal software requirements are as follows:
 - Android OS version 4.4.2 (Samsung Tab Pro)
 - Android OS version 4.4.4 (aValue Classic, aValue Advantage)
 - Android OS version 5.0.2 (aValue Samsung Note Pro)
 - Android OS version 5.1.1 (aValue Prime, aValue Advantage)
 - Android OS version 8.1 (aValue Classic, aValue Prime)
 - Google Text-to-Speech 3.15.18

3.6.3 Physical Interfaces

The Samsung ImageCast[®] X Voting Terminal has a standard micro USB port that is used to connect to LavaLink USB Hub. BMD printer is connected to one of the available ports on the aValue or LavaLink Adapter. Optionally, an ATI or a Tecla Shield device is connected to the voting terminal (directly to aValue, or via LavaLink adapter for Samsung tablet). Tecla Shield device supports connection to assistive switches (buttons, sip-and-puff controllers, pedals, joysticks, wheelchair driving controls). The Smart Cards reader is connected to the voting terminal, either directly in case of aValue, or via adapter in case of Samsung. VVPAT printer as well as the thermal (report) printer can only be used in combination with aValue based devices, not with Samsung based devices. It connects to one of the available USB ports.

CHAPTER 4: EXTERNAL AND INTERNAL INTERFACES

4.1 Democracy Suite® EMS Logical Interfaces

As described in Chapter 3, Microsoft SQL Server 2016 is the Relational Database Management System (RDBMS) used within the EMS software platform. Microsoft SQL Server 2016 is powered by the SQL Server Database Engine. The SQL Server Database Engine is the central SQL Server platform used to store, process, and secure data. It provides controlled access and rapid transaction processing to meet the requirements of the EMS EED, RTR, EDT, and ADJ client applications (**Note:** Other EMS applications do not directly communicate with the EMS Data Center servers). Additionally, the EMS EED, RTR, EDT, and ADJ client applications integrate a complete election domain model in the form of an object-oriented framework.

The structure of the EMS Database data model is derived from this object-oriented election domain data model. As a result, the EMS Database represents the election domain data model storage repository. The intelligence of the system is located within the election object-oriented model, which is part of the EMS EED and RTR client applications. These system components use the EMS EED and RTR data layer functionalities to maintain and retrieve election domain entities in the EMS Database. These transaction-oriented platforms provide a high level of reliability and atomicity for the system transactions that occur between client and server system components. In addition, each of the transactions are executed across the TCP/IP data communication layer using SSL encryption to ensure data integrity and confidentiality.

Communication between client applications (EMS EED is the pre-voting application and EMS RTR is the post-voting application) only occurs through the use of the back-end EMS Data Center and voting channel devices (i.e. ImageCast® devices). The EMS EED client application is responsible for defining the overall election domain structure and its election event instances. Voting channel devices (ImageCast® optical tabulators) and EMS RTR client applications are consumers of this election domain. The EMS EED client application is stored in the EMS Database.

- EMS EED has the ability to perform the following logical input activities:
 - Restore the election project from the previously defined election project backup file using a compressed ZIP archive of the election project database.
 - Import election definition data from a third-party entity in the form of an XML election definition file.

- Import recorded dynamic audio files produced by the EMS Audio Studio client application. These audio files are provided as SPX/OGG, RIFX and MP3 speech optimized audio files.
- Import recorded static audio files in the form of SPX/OGG speech optimized audio files.
- Import political party symbols (logos).
- Import of template keywords (contest, choice, instructions) for ballot styling in rich text file format. These keywords are contained within XML files (with a .tco file extension).
- Import ImageCast[®] Evolution, ImageCast[®] Precinct, and ImageCast[®] Central device configuration and behavioral etalon files in XML file format.
- Import EMS system permission rule sets in XML file format.
- Import new reports, or maintain existing reports using report packages (compressed .zip archive)
- EMS EED provides the following logical output interfaces:
 - Ballot images in PDF print-ready format (PDF 1X-a) for use by the ImageCast[®] tabulators.
 - Audio files in RIFX format, ballot images in PNG format, and corresponding XML coordinate files for ImageCast[®] ICP AVS functionality.
 - Audio files in SPX/OGG format and ballot images in PNG format for ImageCast[®] Evolution AVS functionality.
 - Election database in SQLite format to be used by the ImageCast[®] Evolution tabulators.
 - Election definition files in a proprietary binary file format to be used by the ImageCast[®] Precinct and ImageCast[®] Central tabulators.
 - Credential authentication data used to program security keys to be used by the ImageCast[®] tabulators.
 - Device configuration files in proprietary binary format to be used by the ImageCast[®] Precinct tabulators.
 - Device behavioral and configuration files in XML file format to be used by the ImageCast[®] Evolution tabulators.
 - A variety of system level reports in XML, HTML, or PDF format to be used by human or electronic stakeholders.
 - Audio library definition file in XML format which defines the content to be recorded using the EMS Audio Studio client application.

- Election programming station definition file in XML format which defines the relationship between election files, ImageCast[®] tabulators, and iButton security keys that are used by the EMS Election Domain Exchange Station in the programming of memory cards.
- A Mobile Ballot Production definition file that maps polling subdivisions to ballot IDs and allows users to perform polling place on-demand ballot printing.
- EMS EED also exposes/provides the following logical input/output interfaces:
 - The EMS Data Layer Transactions (serialized binary data) toward the EMS Database Server.
 - The EMS Data Layer Transactions (serialized binary data) toward the EMS Application Server (for optional mixed local intranet and remote Internet configuration).
- The EMS Database Server exposes/provides the following logical input/output interfaces:
 - The Microsoft SQL Database Engine (serialized binary data) for operation in the EMS EED, ADJ, and RTR client applications.
 - The Microsoft SQL Database Engine (serialized binary data) for use in the EMS Application Server (for optional mixed local intranet and remote Internet configuration).
- The EMS Application Server exposes the following logical input/output interfaces:
 - The serialized binary communication channel for use in the remote EMS EED and EMS RTR client applications.
 - The serialized binary communication channel for operation in the EMS Database Server.
- EMS RTR allows for the following logical inputs:
 - User input from the EMS human stakeholders.
 - Result files in proprietary binary file format collected from the ImageCast[®] Precinct and ImageCast[®] Central tabulators.
 - Result files in XML format collected from the ImageCast[®] Evolution tabulators.
 - Imported ImageCast[®] ballot counters.
 - Imported scanned ballot images from the ImageCast[®] Evolution, ImageCast[®] Precinct, and ImageCast[®] Central ballot counters.

- Imported XSLT (XML Stylesheet Transformation Templates) used to define election result reports.
- EMS RTR provides the following logical output interfaces:
 - Result reports in XML, PDF, HTML, or Excel format used by EMS human and electronic stakeholders.

NOTE: the type of exported data depends on the XSLT transformations.

- Result exports in XML, .txt, or JSON format used by EMS human and electronic stakeholders.
- EMS ADJ allows for the following logical inputs:
 - User input from the EMS human stakeholders.
 - Result files in proprietary binary format collected from the ImageCast[®] Central tabulators.
 - Imported scanned ballot images from the ImageCast[®] Central tabulators.
- EMS ADJ provides the following logical output interfaces:
 - Result files in proprietary binary file format.
 - Result reports in PDF or Excel format used by EMS human and electronic stake-holders.

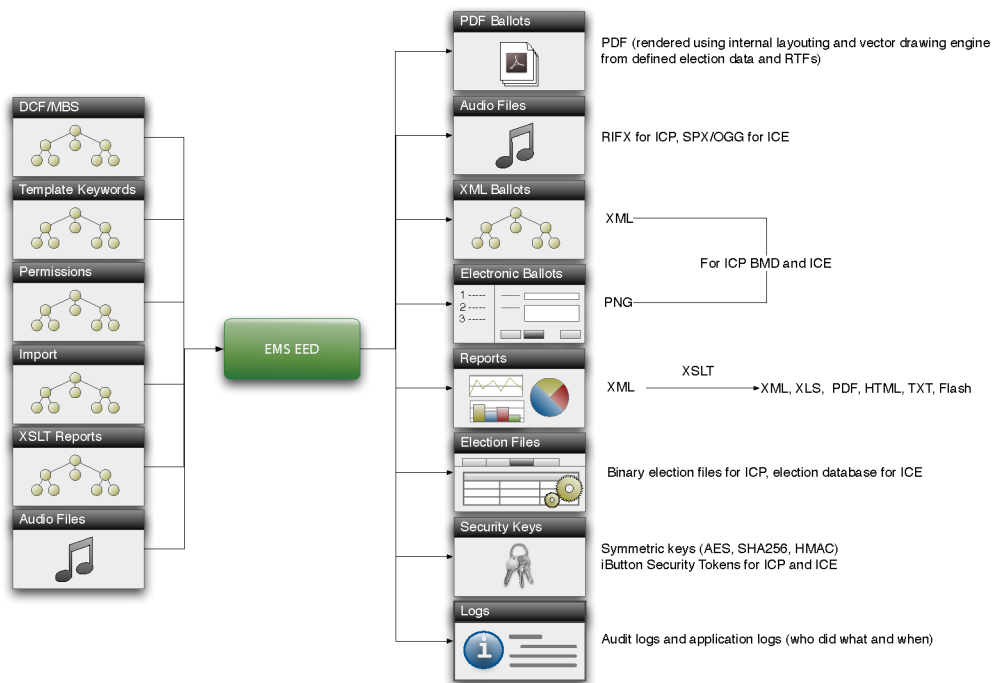

Figure 4-1: The EMS EED Logical Input and Output Interfaces.

A block diagram of the default EMS logical interface can be seen in Figure 4-1. The diagram shows that all communication links can be encrypted. For example, the EED and RTR client applications communicate with the EMS Database Server using the SSL communication channel that contains 128-bit encryption. Alternatively, election files that originate from the EMS EED client application to be used in the ImageCast[®] series of optical ballot scan devices are signed using the keyed one-way hash function (SHA256 HMAC) and then encryption protected (AES256 algorithm). The election files originating from the ImageCast[®] series of tabulators to be used in the EMS RTR client application are also signed using the keyed one-way hash function (SHA256 HMAC) and encryption protected (AES256 algorithm).

4.2 Democracy Suite[®] EMS Physical Interfaces

With regards to physical interfaces, the EMS platform utilizes human-computer interfacing devices, TCP/ IP networking technologies, and traditional computer-based storage devices:

- Communication between the EMS server and the client system components (computer hosting devices) is performed over a Gigabit Ethernet network which utilizes the TCP/IP protocol stack. This interface is only required when EMS Standard hardware configurations are used.
- Communication between EMS client applications (EED, RTR, ADJ, AS, FSS, EDT, RTM, and EDES) and human system stakeholders is performed using human-interfacing devices, such as mouse, keyboard, monitor, and audio recording tools.
- Communication between the EMS system and the voting channel equipment, such as the ImageCast[®] optical tabulators, occurs through the use of Compact Flash memory cards and paper ballots.
- Security provisioning for user security credentials and encryption key exchange is performed using the iButton security keys on the ImageCast[®] tabulators.

4.3 ImageCast[®] Evolution Logical Interfaces

The ImageCast[®] Evolution optical tabulator platform only logically communicates with the EMS software platform. The EMS software platform generates the memory card content used to program ImageCast[®] Evolution devices for a given election event. In addition, the ImageCast[®] Evolution optical tabulator generates election result files and other content that is imported into the EMS software platform.

- With regards to logical input interfaces, the ImageCast[®] Evolution platform accepts the following files from the EMS software platform:
 - Election Database: Represents the SQLite database file that defines the election project, including the set of ballots (and their contests and candidates) to be processed by the given instance of the ImageCast[®] Evolution device.
 - Device Behavioral Settings: Represents the XML file that defines the behavior of the ImageCast[®] Evolution devices. This file determines how the ImageCast[®] Evolution device will operate.
 - Device Configuration Files: A set of XML files that define various operational and look and feel aspects of the ImageCast[®] Evolution device.
 - Ballot Images: Electronic ballot images in PNG format used for an Accessible Voting Session.
 - Audio Files: A set of static and dynamic audio files in SPX OGG format used for an Accessible Voting Session.
 - Resource Files: A set of image files in PNG and SVG format used to manipulate skins to change the look and feel of the ImageCast[®] Evolution user interface.
- With regards to logical output interfaces, the ImageCast[®] Evolution platform generates the following files to be imported by the EMS software platform:
 - Raw Results Files: A per ballot XML file which records all voter marks for a given ballot. This format allows a voting session to be comprehensively audited.
 - Tabulated Results Files: A per tabulator XML file which records consolidated election results for a given tabulator. This format allows election night result reporting and tallying to be performed quickly and efficiently.
 - Scanned Ballot Images: Electronic images of scanned ballots in PNG format.

- **Scanned Ballot Watermarks:** Electronic images of the marks detected on a given ballot.
- **Audit Log:** A text file which records all the activities performed on the device and timestamps of performed these activities.

In addition to memory cards, the ImageCast[®] Evolution also receives a set of iButton Security Keys. These iButton security keys are programmed with the assistance of the EMS software platform and store user security credentials (username and password) as well as the SHA256 and AES256 cryptographic keys.

All memory card content is digitally signed. Files that require data confidentiality are encrypted. As a result, the logical communication channel between the ImageCast[®] Evolution and the EMS software platform's data is protected and kept confidential.

4.4 ImageCast[®] Precinct Logical Interfaces

The ImageCast[®] Precinct optical tabulator interfaces with pre-voting and post-voting Democracy Suite[®]

EMS components through sets of election files as described in Section 4.1. As its input, it receives the Voting Information File (VIF) and Device Configuration File (DCF), both of which are created by the Democracy Suite[®] EMS EED pre-voting application for each instance of the ImageCast[®] Precinct device. As its output, the ImageCast[®] Precinct provides a Results Information File (RIF) toward the Democracy Suite[®] EMS RTR post-voting application.

In addition to these election files, the ImageCast[®] Precinct tabulation device utilizes security credentials and encryption keys created by the EMS EED application.

4.5 ImageCast[®] Precinct Physical Interfaces

4.5.1 I/O Ports

4.5.1.1 RS232 Port

The RS232 port (19,200 BAUD with no flow control) is provided for debugging purposes and external unit management. This port can be enabled and disabled under software control.

4.5.1.2 Modem Port

The Modem Port provides optional connectivity for standard Socket Modems (built-in universal modem socket to support standard embedded Socket Modem modules). In the case of Dial-Up modems, one RJ11 connector is provided for the phone line connection. The Universal Socket is connected to the processor via a UART port.

4.5.2 Integrated USB Port

The ImageCast[®] Precinct has an integrated USB port that is used to connect the UPS to the ImageCast[®] Precinct unit.

4.5.3 Power Input

The ImageCast[®] Precinct has two main power sources: an external AC adapter and an internal battery which are both connected to the internal power module. The AC adapter is connected to the module via a standard 2.1mm plug, and the battery is connected via an internal 14-pin connector.

4.5.4 Removable Memory

The ImageCast[®] Precinct has two Type II Compact Flash (CF) memory slots that conform to the Personal Computer Memory Card International Association ATA standard.

4.5.5 Security Interface

The ImageCast[®] Precinct integrates one 1-wire iButton security interface for software validation, access control, and other security features. This interface is used in conjunction with secure SHA iButton security keys that utilize the SHA-1 engine for FIPS and ISO/IEC 10118-3 compliance.

A detailed hardware description is provided in *2.04 - Democracy Suite[®] ImageCast[®] Precinct System Hardware Specification*.

4.6 ImageCast[®] Evolution Physical Interfaces

4.6.1 I/O Ports

4.6.1.1 RS232 port

The RS232 port (19,200 BAUD with no flow control) is provided for debugging purposes and external unit management. The port can be enabled and disabled under software control.

4.6.1.2 AVS Vote - Accessibility Port

The ImageCast[®] Evolution integrates a UART (RJ45) based port to connect the Audio Tactile Interface (ATI) unit. The ATI is part of the device's accessible voting functionality.

4.6.1.3 USB Port

The ImageCast's USB 2.0 port is part of the AVS voting interface and allows connections to be made with the external standard USB to VGA based monitor. In addition, the same port can be used for connecting the qualified USB modems. The port is driven by a build in CPU USB host controller.

4.6.2 Power Input

The ImageCast[®] Evolution has two main power sources: an external AC adapter and an internal battery. Both of these sources are connected to the internal power module. The AC adapter is connected to the module via a standard 2.1mm plug and the battery is connected via an internal 14-pin connector.

4.6.3 Removable Memory

The ImageCast[®] Evolution contains two Type II Compact Flash (CF) memory slots that conform to the Personal Computer Memory Card International Association ATA standards.

4.6.4 Security Interface

The ImageCast[®] Evolution integrates one 1-wire iButton security interface for software validation, access control, and other security features. This interface is used in conjunction with the iButton security keys that carry the security credentials and cryptographic keys necessary for proper system operation. A detailed hardware description is provided in *2.04 - Democracy Suite[®] ImageCast[®] Evolution System Hardware Specification*.

4.7 ImageCast® Central Logical Interfaces

The ImageCast® Central optical ballot scan devices utilize the same set of logical interfaces as the Precinct model. The same type of input election configuration files (VIF and DCF) as the Precinct model are used to program devices. In addition to scanned ballot images, the device produces the same type of output election results files (RIF).

4.8 ImageCast® Central Physical Interfaces

The ImageCast® Central Scanner uses a standard interface to connect to the ImageCast® Central Workstation. The ImageCast® Central Workstation uses a standard Gigabit Ethernet Port to establish LAN connectivity. The ImageCast® Central Workstation also contains built-in standard PC physical interfaces (USB, keyboard, mouse, monitor, DVD ROM, etc.).

4.9 ImageCast® Remote Logical Interfaces

The ImageCast® Remote platform only logically communicates with the EMS software platform. The EMS software platform generates the election project used to program ImageCast® Remote applications logical data center for a given election event. In BMD configuration, the ImageCast® Remote Voting application generates Electronic Mobile Ballots that can be printed and scanned on ImageCast® Central, ImageCast® Precinct or ImageCast® Evolution tabulator. With regards to logical input interfaces, the ImageCast® X platform accepts the following files from the EMS software platform:

- **Election Database:** Represents the encrypted and signed SQLite database file that defines the election project, including the set of ballots (and their contests and candidates) to be processed by the given instance of the ImageCast® Remote application.
- **Electronic Mobile Headers:** Set of PNG files that defines headers of Electronic Mobile Ballots With regards to logical output interfaces, the ImageCast® X platform generates the following artifacts:
- **BMD:** Printed Electronic Mobile Ballots that will be scanned and tabulated by ImageCast® Central, ImageCast® Precinct or ImageCast® Evolution tabulator
- **Audit Log:** Text file which records all the activities performed on the platform and timestamps of performed activities.

4.10 ImageCast[®] X Logical Interfaces

The ImageCast[®] X platform only logically communicates with the EMS software platform. The EMS software platform generates the memory content used to program ImageCast[®] X devices logical data center for a given election event. In BMD configuration, the ImageCast[®] X Voting terminal prints Electronic Mobile Ballots that can be scanned on ImageCast[®] Central, ImageCast[®] Precinct or ImageCast[®] Evolution tabulator. In DRE configuration, the ImageCast[®] X Voting terminal records votes directly into an encrypted Cast Vote Record container that can be loaded directly into Results Tally and Reporting[™]. With regards to logical input interfaces, the ImageCast[®] X platform accepts the following files from the EMS software platform:

- Election Database: Represents the encrypted and signed SQLite database file that defines the election project, including the set of ballots (and their contests and candidates) to be processed by the given instance of the ImageCast[®] X device.
- Audio Files: Set of static and dynamic audio files in Speex (SPX) format used for an Accessible Voting Session.
- Electronic Mobile Headers: Set of PNG files that defines headers of Electronic Mobile Ballots

With regards to logical output interfaces, the ImageCast[®] X platform generates the following artifacts:

- BMD - Printed Electronic Mobile Ballots that will be scanned and tabulated by ImageCast[®] Central, ImageCast[®] Precinct or ImageCast[®] Evolution tabulator
- DRE - Signed and encrypted Cast Vote Record that can be loaded into Results Tally and Reporting[™].
- DRE - Reports that can be printed on the thermal printer and/or stored locally on the device
- Audit Log: Text file which records all the activities performed on the platform and timestamps of performed activities.

4.11 ImageCast® X Physical Interfaces

The ImageCast® X Voting terminal is equipped with standard USB 2.0 ports that allow it to connect to various peripherals.

4.12 Benchmark Directory

4.12.1 Democracy Suite® EMS Software Release Package

The EMS Election Event Designer EED installation package consists of:

- 64-bit version:
 - EEDFED CERT Setup 64.msi
 - EEDFED CERT Setup 64.msi.sha
 - setup.exe
 - setup.exe.sha

The application is installed in the following folder: C:\Program Files\Dominion Voting Systems\Election Event Designer Numerous executable library files are installed within this directory.

The EMS Results Tally and Reporting RTR installation package consists of:

- 64-bit version:
 - RTR FED CERT Setup x64.msi
 - RTR FED CERT Setup x64.msi.sha
 - setup.exe
 - setup.exe.sha

The application is installed in the following folder: C:\Program Files\Dominion Voting Systems\Results Tally and Reporting Numerous executable library files are installed within this directory.

The Adjudication installation package consists of The Adjudication client application and The EMS Adjudication Services installation packages:

- 32-bit version:
 - DVS Adjudication Services Setup.msi
 - DVS Adjudication Services Setup.msi.sha
 - DVS ImageCast Adjudication Client Setup.msi
 - DVS ImageCast Adjudication Client Setup.msi.sha
 - InstallWithLogging.bat

The application is installed in the following folder: C:\Program Files (x86)\Dominion Voting Systems\Adjudication Numerous executable library files are installed within this directory.

The EMS Audio Studio AS installation package consists of:

- 32-bit version
 - EMSAudioStudioSetup.msi
 - EMSAudioStudioSetup.msi.sha
 - setup.exe
 - setup.exe.sha

The application is installed in the following folder: C:\Program Files(x86)\Dominion Voting Systems\Audio Studio The executable and numerous library files will be installed within this directory.

The EMS File System Service (EMSFSS) installation package consists of:

- 32bit version:
 - FSSSetup.msi
 - FSSSetup.msi.sha
 - setup.exe
 - setup.exe.sha

The application is installed in the following folder: C:\Program Files(x86)\Dominion Voting Systems\File System Service The executable and numerous library files will be installed within this directory.

The Smart Card Helper Service installation package consists of:

- 64bit version:
 - SmartCardServiceSetup.msi
 - SmartCardServiceSetup.msi.sha
 - setup.exe
 - setup.exe.sha

The application is installed in the following folder: C:\Program Files\Dominion Voting Systems\Smart Card Service The executable and numerous library files will be installed within this directory.

The EMS Election Data Translator (EMSEDТ) installation package consists of:

- 32bit version:
 - EDTSetup x86.msi
 - EDTSetup x86.msi.sha

- setup.exe
- setup.exe.sha

The application is installed in the following folder: C:\Program Files (x86)\Dominion Voting Systems\Election Data Translator Numerous executable library files are installed within this directory.

- 64bit version:
 - EDTSetuo x64.msi
 - EDTSetup x64.msi.sha
 - setup.exe
 - setup.exe.sha

The application is installed in the following folder: C:\Program Files\Dominion Voting Systems\Election Data Translator Numerous executable library files are installed within this directory.

The EMS Result Transfer Manager (EMSRTM) installation package consists of:

- 64bit version:
 - RTMClient.Setupx64.msi
 - RTMClient.Setupx64.msi.sha
 - RTMClient.Setupx64.wixpdb
 - RTMClient.Setupx64.wixpdb.sha
 - setup.exe
 - setup.exe.sha

The application will be installed in the following folder: C:\Program Files\Dominion Voting Systems\Results Transfer Manager Client The executable and numerous library files will be installed within this directory.

The EMS Mobile Ballot Production (MBP) installation package consists of:

- 32bit version:
 - MBPSetup.msi
 - MBPSetup.msi.sha
 - MBPSetup.wixpdb
 - MBPSetup.wixpdb.sha
 - setup.exe
 - setup.exe.sha

The application will be installed in the following folder: C:\Program Files(86)\Dominion Voting Systems\Mobile Ballot Production The executable and numerous library files will be installed within this directory.

The EMS Image Cast Voter Activation installation package consists of:

- 64-bit version:
 - ICVASetup.msi
 - ICVASetup.msi.sha
 - setup.exe
 - setup.exe.sha

The application will be installed in the following folder: C:\Program Files\Dominion Voting Systems\ICVA The executable and numerous library files will be installed within this directory.

The EMS Application Server installation package consists of:

- 64-bit version:
 - APPS FED CERTSetup x64.msi
 - APPS FED CERTSetup 64.msi.sha
 - setup.exe
 - setup.exe.sha

The application will be installed in the following folder: C:\VirtualDirectories\EMSApplicationServer The executable and numerous library files will be installed within this directory.

The EMS Service installation package consists of:

32bit version:

- EMSServiceSetup.msi
- EMSServiceSetup.msi.sha
- setup.exe
- setup.exe.sha

The application will be installed in the following folder: C:\VirtualDirectories\EMSService The executable and numerous library files will be installed within this directory.

The EMS Data Center Manager (EMSDCM) executable package consists of:

- 32bit version:
 - DemocracySuiteEMS DCM.exe
 - DemocracySuiteEMS DCM.exe.sha

- DemocracySuiteEMS DCM.exe.config
- DemocracySuiteEMS DCM.exe.config.sha
- democracysuiteems dcm.exe.hash
- DVS.Utilities.Common.dll
- DVS.Utilities.Common.dll.sha
- DVS.Utilities.MSWinManager.dll
- DVS.Utilities.MSWinManager.dll.sha
- NLog.config
- NLog.config.sha
- NLog.dll
- NLog.dll.sha
- Static.zip
- Static.zip.sha

EMS DCM is not an installable program; it is an executable used only to configure a machine as per user requests and configuration used. It creates all the necessary folders and adjusts privileges required for all other EMS components.

EMS PREREQUISITES installation package consist of third-party components, which need to be installed before installation of EMS components.

The ImageCast[®] Listener Server and Client Installation packages consist of:

- ImageCast[®] Listener Service (runs from ImageCast[®] Listener Servers)
 - 64-bit version:
 - ServiceInstaller.msi
 - Setup.exe
- EMS Shell Service (runs from EMS Servers)
 - 64-bit version:
 - DVS.EMS.ShellService.msi
 - Setup.exe
- Cartridge Management (runs from EMS Servers)
 - 64-bit version:
 - CartridgeManagement.msi
 - Setup.exe
- Transmission Dashboard (runs from PC Client)

- 64-bit version:
 - DVS.EMS.UI.Shell.DashboardInstaller.msi
 - Setup.exe

4.12.2 Democracy Suite® ImageCast® Evolution Firmware Release Package

As per certification regulations, only certified firmware and software can be released to jurisdictions. As such, there is no release package procedure to be followed for firmware. The tabulators come with the firmware already installed. If an updated release is issued, the certification process must occur, after which a controlled update must be performed by Dominion technical staff.

4.12.3 Democracy Suite® ImageCast® Precinct Firmware Release Package

As per certification regulations, only certified firmware and software can be released to jurisdictions. As such, there is no release package procedure to be followed for firmware. The tabulators come with the firmware already installed. If an updated release is issued, the certification process must occur, after which a controlled update must be performed by Dominion technical staff.

4.12.4 Democracy Suite® ImageCast® Central Count Application Software Release Package

As per certification regulations, only certified firmware and software can be released to jurisdictions. As such, there is no release package procedure to be followed for firmware. The tabulators come with the firmware already installed. If an updated release is issued, the certification process must occur, after which a controlled update must be performed by Dominion technical staff.

4.12.5 Democracy Suite® ImageCast® X Software Release Package

The ImageCast® X installation package consists of:

- ICX.apk
- google.tts 3.11.12-x86.apk
- google.tts 3.11.12-arm.apk

CHAPTER 5: SYSTEM PERFORMANCE

5.1 System Capacity

5.1.1 Democracy Suite[®] EMS System Capacity

The Democracy Suite[®] EMS platform does not impose any restrictions on the following system capacity aspects related to the problem domain:

- Number of EMS EED client applications simultaneously used within the system
- Number of EMS RTR client applications simultaneously used within the system
- Number of election projects supported by a single instance of the system
- Size and complexity of the election project structure (number of political subdivisions, number of contests and candidates, number of polling locations, ImageCast[®] tabulators, etc.)

The tables 5.1 and 5.2 presents the system limitations in regards to ballot orientation:

Limit (Maximum Number)	Value (by configuration)		Limiting Component
	Express	Standard	
Ballot Positions	292	292	22 Inch Landscape Ballot (240 candidates + 24 write-ins + 28 Yes/No choices)
Precincts in Election	250	1000	Memory
Contests in Election	250	1000	Memory
Candidates/Counters in Election	2500	10000	Memory
Candidates/Counters in Precinct	240	240	22 Inch Landscape Ballot
Candidates/Counters in Tabulator	2500	10000	Memory
Ballot Styles in Election	750	3000	Memory

Table 5-1: Democracy Suite[®] System Limits (Landscape Ballot Orientation)

Limit (Maximum Number)	Value (by configuration)		Limiting Component
	Express	Standard	
Contests in a Ballot Style	38	38	22 Inch Landscape Ballot (24 candidacy contests + 14 propositions)
Candidates in a Contests	240	240	22 Inch Landscape Ballot
Ballot Styles in a Precinct	5	5	Memory
Number of Parties	30	30	Memory
Vote For in Contest	24	24	22 Inch Landscape Ballot
Supported Languages per Election	5	5	Memory
Number of Write-ins	24	24	22 Inch Landscape Ballot

Table 5-1: Democracy Suite[®] System Limits (Landscape Ballot Orientation)
 . (Continued)

Limit (Maximum Number of)	Value (by configuration)		Limiting Component
	Express	Standard	
Ballot Positions	462	462	22 Inch Portrait Ballot
Precincts in Election	250	1000	Memory
Contests in Election	250	1000	Memory
Candidates/Counters in Election	2500	10000	Memory
Candidates/Counters in Precinct	462	462	22 Inch Portrait Ballot
Candidates/Counters in Tabulator	2500	10000	Memory
Ballot Styles in Election	750	3000	Memory
Contests in a Ballot Style	156	156	22 Inch Portrait Ballot

Table 5-2: The Democracy Suite[®] System Limits (Portrait Ballot Orientation)
 .

Limit (Maximum Number of)	Value (by configuration)		Limiting Component
Candidates in a Contests	231	231	22 Inch Portrait Ballot (Column Span 3)
Ballot Styles in a Precinct	5	5	Memory
Number of Parties	30	30	No Limitation
Vote For in Contest	30	30	No Limitation
Supported Languages per Election	5	5	Memory
Number of Write-ins	462	462	22 Inch Portrait Ballot

Table 5-2: The Democracy Suite[®] System Limits (Portrait Ballot Orientation) . (Continued)

All of the above listed system capacity attributes are limited with regards to the number and size of the underlying computing and networking infrastructure:

- EMS hardware configuration deployed
- Number of Gigabit Ethernet ports on the active network equipment
- Number and size of the hard disk storage media on the EMS Database Server and NAS servers

5.1.2 ImageCast[®] Evolution System Capacity

The following is a list of recommended precinct system limitations:

- 2500 stored ballots per scanner unit
- 100 EDs per scanner unit
- 100 ballot styles per scanner unit
- 900-2000 voters per day depending on the ballot complexity

The ImageCast[®] Evolution (ICE) system capacity can be measured by processing speed and memory card capacity. The ballot processing speed is defined by the ballot size (length). The average ImageCast[®] ballot processing speed is in the range of two seconds.

Images of all paper ballots are processed on the tabulator and saved on the memory card. Memory card size (available in 2 GB, 4 GB, 8 GB and 16 GB) is important in determining the ImageCast[®] 's ballot storage capacity.

The ICE memory card has only one partition that holds the ballot images, election database, audio files, etc. Table 5-3 below shows the approximate ballot capacities for various ballot size and memory card size when 512MB is estimated for the election database, audio files, etc. and the remaining space is allocated for storing ballot images. The ICE requires approximately 600kb per processed 22” double-sided ballot.

The ICE unit monitors the memory card free space and will warn the poll worker when the remaining free spaces reaches 5%. At 2% remaining free space, the ICE unit will process the current ballot in progress and will not allow any further ballots to be processed on that memory card.

		Memory Card Size			
Ballot Size (Single-Sided)	Approx Ballot Image Size (KB)	2 GB	4 GB	8 GB	16 GB
8.5” x 11”	250	6000	14000	30000	62000
8.5” x 14”	277	5400	12600	27000	55800
8.5” x 17”	312	4800	11200	24000	49600
8.5” x 20”	334	4500	10500	22400	46400
8.5” x 22”	357	4200	9800	21000	43400
Ballot Size (Double-Sided)					
8.5” x 11”	357	4200	9800	21000	43400
8.5” x 14”	454	3300	7700	16500	34100
8.5” x 17”	499	3000	7000	15000	31100
8.5” x 20”	555	2700	6300	13500	27900
8.5” x 22”	624	2400	5600	12000	24800

Table 5-3: ImageCast[®] Evolution Ballot Image Capacity for Various Ballot Sizes and Memory Card Sizes

As an example, on a memory card programmed for Miami-Dade election on an early voting unit that contains 749 precincts (with some splits), the election database with audio files and other required files consumes approximately 2.7 GB of the memory card space. Alternatively, on a memory card programmed with for the same election with one (1) precinct, the election database, audio files and other required files only consumes 12MB of the memory card space. When determining memory card capacity, it is important to understand how much of the memory card space will be consumed with the election programming data and how much space remains for ballot image storage.

5.1.3 ImageCast[®] Precinct System Capacity

The following is a list of recommended precinct system limitations:

- 2500 stored ballots per scanner unit
- 100 EDs per scanner unit
- 100 ballot styles per scanner unit
- 900-2000 voters per day depending on the ballot complexity

The ImageCast[®] Precinct system capacity can be measured by processing speed and memory card capacity. The ballot processing speed is defined by the ballot size (length). The average ImageCast[®] Precinct ballot processing speed is within the range of six to seven seconds.

Images of all paper ballots are processed on the tabulator and saved on the memory card. Memory card size (available in 2 GB, 4 GB, 8 GB, and 16 GB) determines the ImageCast[®] 's ballot storage capacity.

The ICP memory card has a fixed partition that holds the election database, audio files, etc., and the remaining space on the memory card is used for storing ballot image files. Table 5-4 shows the approximate ballot capacities for various ballot size and memory card size when 512MB is used for the fixed partition that holds the election database, audio files, etc., and the remaining space is allocated for storing ballot images. The ICP requires approximately 600kb per each processed, 22" double-sided ballot.

The ICP can be configured through its DCF configuration settings to limit the maximum number of ballots that can be processed onto a memory card. Based on the ballot sizes to be processed through a unit, along with the information in the table below, the election administrator can determine a maximum value for the number of ballots to be processed on a memory card in order to configure the DCF configuration settings for that unit.

		Memory Card Size			
Ballot Size (Single-Sided)	Approx. Ballot Image Size (KB)	2 GB	4 GB	8 GB	16 GB
8.5" x 11"	258	5800	13500	29000	59900
8.5" x 14"	286	5200	12200	26200	54200
8.5" x 17"	325	4600	10700	23000	47700
8.5" x 20"	352	4200	9900	21300	44000
8.5" x 22"	382	3900	9100	19600	40500
Ballot Size (Double-Sided)					
8.5" x 11"	382	3900	9100	19600	40500
8.5" x 14"	476	3100	7300	15700	32600
8.5" x 17"	517	2900	6800	14500	30000
8.5" x 20"	564	2600	6200	13300	27500
8.5" x 22"	633	2400	5500	11800	24500

Table 5-4: ImageCast[®] Precinct Ballot Image Capacity for Various Ballot Sizes and Memory Card Sizes

5.1.4 ImageCast[®] Central Count System Capacity

Depending on the scanner used, ImageCast[®] Central provides a scanning speed of up to 150 pages per minute. Multiple ImageCast[®] Central systems can be used in parallel to increase overall system capacity.

5.1.5 ImageCast[®] X System Capacity

The following is a list of recommended system limitations:

- 1000 EDs per unit
- 1000 ballot styles per unit

- 900-2000 voters per day depending on the ballot complexity
- Election file size should not exceed 10GB
- BMD limits:
 - Not more than 5 vote-for positions
 - Max 250 choices per contest
 - Max 108 contests on Letter paper
 - Max 153 contests on Legal paper

5.2 Quality Attributes

5.2.1 Democracy Suite[®] EMS Quality Attributes

The Democracy Suite[®] EMS platform is architected, designed, and developed according to the software quality metrics defined in ISO 9126, which was overseen by ISO 25000:2005. In addition to the subjects described in this section, these software quality metrics include system functional areas, such as security, accuracy, interoperability, etc.

In some cases, overlap occurs between international standards that contain IEEE recommendations. This is especially true with the IEEE 982 series of recommendations, which are also related to software level quality metrics. In addition, the EMS platform quality attributes are strongly related to the accepted software development processes and methodologies. In this situation, these processes and methodologies are based on Unified Process (UP) and Agile software development practices.

5.2.1.1 Reliability

Software system reliability is determined by the quality of the software development processes, as well as the products of these processes. Some examples include functional, design and test document sets, source code, and accepted development best practices.

As a primary goal, these processes, and the products of these processes, must help prevent software errors from occurring. They must also assist in the detection and removal of faults. Doing so provides more reliable and fault-free software platforms.

To prevent errors related to programmer actions or omissions that result in software failures, the system functional requirements must be clearly defined to begin. If software development teams know what they must design and develop from the outset, they will produce a smaller number of errors. However, in this case, the software methodology process is based on the Unified Process which is iterative in nature. This means that the definition of requirements is also repetitive.

During the initiation of a software development project, more emphasis is placed on the definition of requirements and less on development and testing. However, in later iterations, the amount of time spent on defining requirements is reduced, while the time spent on development and testing increases. This approach is based on the rationale that it is often impossible to define all software system functional requirements before the rationale development process begins. This approach is most common for the failure-prone “waterfall” software development methodology. According to this perspective, the Democracy Suite[®] EMS platform is based on the clearly defined, documented, reviewed, and approved functional requirements blueprint document.

The next step in preventing errors is to reduce the complexity of the software modules that comprise the Democracy Suite[®] EMS platform. The complexity of software modules is slightly more difficult to define for object-oriented software platforms such as the Democracy Suite[®] EMS platform than for procedural programming languages. However, in both cases, software module complexity can be analyzed by taking into account the size, dependencies and logical (data flow) complexity of the software modules.

The next step in refining the source code is the execution of two additional code analysis tools:

- Microsoft FxCop: A code analysis tool that checks .NET C# (programming language used for Democracy Suite[®] EMS development) managed code assemblies so that they conform to the Microsoft .NET Framework Design Guidelines. This tool uses reflection, MSIL (Microsoft Intermediate Language) parsing, and call-graph analysis to inspect assemblies for more than 200 defects in the following areas:
 - Assembly design
 - Localization
 - Naming conventions
 - Performance
 - Security
- Refactoring and code inspection tools: Code refactoring improves source code readability, simplifies its structure, and enforces coding standards and best practices without changing the code logic. The code inspection tools aid in the process of peer-to-peer code review among developers and business stakeholders.

According to functional specifications and the corresponding test specifications, Democracy Suite[®] EMS source code is only prepared and approved for system level testing procedures after these phases are performed. Because Democracy Suite[®] EMS follows this approach, it is one of the most reliable election management systems.

5.2.1.2 Maintainability

Software development practices used in the Democracy Suite[®] EMS development process are fully applicable to the maintainability quality metrics. The primary maintainability attributes provided by this development methodology are greater system stability, analyzability, changeability, and testability. As a result, it is easier to maintain source code and correct problems found in the field or testing lab after the initial software release and, by following the overall ISO 20000 (ITIL), to maintain source code and correct problems found in change and release management process.

5.2.1.3 Availability

The Democracy Suite[®] EMS platform utilizes off-the-shelf standard computing technologies, such as server and workstation computers. In addition, full system deployment relies on active and passive networking equipment. Proper configuration of these application-hosting platforms is essential in establishing overall system availability. Democracy Suite[®] EMS is an election project-oriented platform, whereas the EMS Database Server is the central repository of the defined pre-voting data and post-voting election results. As a result, the main goal of this availability strategy is to properly architect the back-end system components.

As described previously, the EMS Database Server is implemented on top of MS SQL Server 2016 and hosted on industrial-grade server hardware. By utilizing RAID disks and redundant pairs of database server platforms with scheduled replications of the database, seamless availability of the back-end system is achieved.

5.2.1.4 Usability

The graphical user interface of the Democracy Suite[®] client applications (Election Event Designer and Results Tally and Reporting) is designed with usability best practices in mind, and take into account the following usability attributes:

- Size of the text and the graphical components of the application interface
- Color selection of the interface components
- Support for all hosting operating system accessibility functions (magnification, etc.)
- Availability of context help screens, as well as detailed user manuals
- Availability of dynamic training materials

5.2.1.5 Portability

Three main attributes are considered in the definition of portability: installability, replaceability, and adaptability. Democracy Suite[®] EMS integrates a simple procedure to be followed in the installation of Election Event Designer and Results Tally and Reporting client applications. The process is similar to the installation of any MS Windows application.

Replaceability can be considered at an application, library, or source code level. From an application point of view, new releases of the EED and RTR client applications can be installed without uninstalling the previous versions, while maintaining backward compatibility.

On the library level, the system does not allow single library files to be replaced without re-installing the complete application. This practice is enforced to protect the application's overall integrity.

Finally, on the source level, the application code is written in the .NET Framework C# programming language, but components of the system can be replaced by using differently managed components written in other object-oriented programming languages.

Adaptability of the EMS platform components is defined on the level of the overall application. This means that applications contain certain operational requirements that cannot be changed (for example, EED and RTR both require Windows OS with .NET Framework 4.x to be installed). However, the application may be adapted towards different user groups based on the application's roles or language profiles.

5.2.2 ImageCast[®] Evolution and ImageCast[®] Precinct Ballot Counter Quality Attributes

The ImageCast[®] Evolution and ImageCast[®] Precinct Ballot Counter Quality Attributes (reliability, maintainability, availability, etc.) are fully defined in:

- *2.04.1-Democracy Suite[®] ImageCast[®] Evolution System Hardware Characteristics*
- *2.04.1-Democracy Suite[®] ImageCast[®] Precinct System Hardware Characteristics.*

The following is a brief overview of the Ballot Counter Quality Attributes.

5.2.2.1 Reliability

The ImageCast[®] system is designed for use in real-world election conditions. The measurements below measure the total operating time before failure.

For certification testing, the system operations scenario consists of approximately 45 hours of equipment operation, 30 hours of equipment set-up and readiness testing, and 15 hours of elections operations.

For Dominion's internal purposes, system operation only consists of the hours in which the machines are in operation in the voting locations (approximately 11 hours each voting day). This is significantly more stringent than the certification requirement.

The measured values from 2008 onwards are as follows:

MTBF	900 hours
------	-----------

5.2.2.2 Maintainability

The ImageCast[®] system is designed to be used in real-world election conditions. One aspect of the mobile computing equipment is that repairs can be made if damage occurs.

The system meets the maintainability requirements of the VVSG. Please refer to the following TDP documents for performance measurements:

- *2.04 - Democracy Suite[®] ImageCast[®] Precinct System Hardware Specification*
- *2.04.1 - Democracy Suite[®] ImageCast[®] Precinct System Hardware Characteristics*

The measured values from 2008 onwards are as follows:

MTTR	0.54 hours
------	------------

5.2.2.3 Availability

The ImageCast[®] system is designed for use in real-world election conditions. Availability is a key performance indicator taken into account in the design of the system.

The system meets the reliability requirements of the VVSG. Please refer to section 5.2.2.1

The measured values from 2008 onwards are as follows:

Ai	99.94%
----	--------

5.2.2.4 Usability

The ImageCast[®] system is designed for use in real-world election conditions. Usability is a key performance indicator considered during system design.

Deterministic study objectives are defined to evaluate the voting system against a set of usability requirements. The primary objective is to provide the voter with the opportunity to test and help improve the usability of the device. Studies are conducted regularly to collect and identify areas that require improvement and to determine to what level the system suits the needs of each voter.

An important aspect worth noting is the ability to provide feedback to the design team to facilitate final improvements to the ballot counting system. Changes may be performed on existing units or may be the subject of future enhancements. Test results for the ImageCast[®] Evolution will be added when available.

5.2.2.5 Portability

Based on its weight and size (as described in 2.04.1 - Democracy Suite[®] ImageCast[®] Precinct System Hardware Characteristics and 2.04.1 - Democracy Suite[®] ImageCast[®] Evolution System Hardware Characteristics) the ImageCast[®] Evolution and ImageCast[®] Precinct Counter hardware satisfies practical portability requirements for the precinct optical scan ballot tabulator.

5.2.3 ImageCast[®] Central Ballot Counter Quality Attributes

The ImageCast[®] Central Ballot Counter Quality Attributes (reliability, maintainability, availability, etc.) are covered in the scanner and ImageCast[®] Central Workstation vendor's documentation.

5.2.4 ImageCast[®] X Voting Terminal Quality Attributes

The ImageCast[®] X Voting Terminal Quality Attributes (reliability, maintainability, availability, etc.) are covered in the vendor's documentation.

5.2.5 Democracy Suite[®] Security Attributes

5.2.5.1 Safety

All system hardware components are tested against various standards to ensure safe operation and reduction of hazards. The ImageCast[®] Evolution ballot counter complies with the applicable UL 609501 standards for safety as well as the required performance characteristics prescribed in the VVSG:

- IEC 61000-4-2 through 6, 61000-4-8, and 61000-4-11
- FCC Class B

- MIL-STD-810D, various Methods

For more information, please refer to 2.04 -Democracy Suite[®] ImageCast[®] Evolution Hardware Specification, Section Compliance.

5.2.5.2 Security

Detailed security characteristics of the Democracy Suite[®] EMS platform are provided in 2.06 - Democracy Suite[®] Democracy Suite[®] System Security Specification. This section will briefly describe some of the security mechanisms used:

- **Access control:** Authentication and authorization mechanisms are integrated within the core of the Democracy Suite[®] EMS system:
 - Access to the central EMS Database can only be performed indirectly by using the EMS EED, EMS RTR, and EMS EDT client applications.
 - The system integrates centrally managed role-based user management.
 - Each role contains a set of permissions that allow or disallow certain system functions.
 - Users always belong to a certain role and cannot perform actions outside the scope of this role.
 - Users have a set of credentials they must use to log in and use the system.
- **Data security:** Data confidentiality and integrity are the mechanisms used to manage data security:
 - Election definition data and voting results data are always stored and transferred in encrypted format.
 - The algorithms used are standards-based and NIST approved (AES).
 - Election definition data and voting results data are always signed using one-way hashing algorithms for data integrity purposes.
 - Algorithms used are standards-based and NIST approved (SHA).
- **Network security:** Active networking equipment is selected and configured to support needed network level security mechanisms:
 - Anti-virus client protection is utilized for both internet and intranet facing systems.

5.2.5.3 Privacy

The Democracy Suite[®] EMS platform does not store any sensitive personal information, and especially not any information related to voters (electors). For the limited candidate information that the system does maintain, data is stored in the EMS Database, and any transference of such data, internally or externally, is protected with regards to authentication, authorization, confidentiality, and integrity. Voter privacy is maintained at all times in the voting location. Ballot secrecy folders are provided to cover ballot selections. No system function is able to tie a voter to a vote selection, even indirectly via an activation key.

5.2.5.4 Continuity of Operation

As part of the overall risk management process, risk analysis and mitigation techniques have been defined for the Democracy Suite[®] EMS continuity of operation. Appropriate processes for the system continuity actions have been defined based on EMS system architecture, impact analysis, and threat analysis.

In the case of the EMS platform, system operation can be jeopardized due to a variety of factors, such as natural disasters, power failures, computing hardware failures, system security breaches, or internal faults within the system. The latter is the most controllable aspect within the system, and some of its mitigation processes have already been addressed. Mitigation for most of the remaining threats should be covered according to defined procedures.

In the case of power failure, the system should deploy appropriate uninterruptible power supply devices that preserve the current state of the system. The damage caused by possible computer hardware failures can be lessened by using redundant systems and by performing scheduled backups. Proper security mechanisms, briefly described in the previous section, should be integrated at the core of the system, thus providing the least amount of vulnerable surface area.

With regards to precinct equipment, all systems are designed to be replaceable during voting hours in order to maintain continuous operation.

5.2.6 Democracy Suite[®] System Constraints

5.2.6.1 Design Constraints

The Democracy Suite[®] EMS system operation requirements were defined in Section 3. There are no other software platform constraints.

5.2.6.2 Applicable Standards

The following standards and recommendations are applicable to Democracy Suite[®] EMS platforms:

- ISO 20000

- ISO 25000
- ISO 17799/27002
- Democracy Suite[®] Coding Standards (internal)
- ECMA 224 - C# Language Specification

5.2.6.3 Compatibility

The Democracy Suite[®] EMS system operation requirements were defined in Section 3. The system is compatible with VVSG 2005 Volume I and II requirements.

5.2.7 ImageCast® Evolution System Constraints

5.2.7.1 Continuity of Operation

Please refer to the following TDP documents:

- *2.03 - Democracy Suite® ImageCast® Evolution Functionality Description*
- *2.04 - Democracy Suite® ImageCast® Evolution System Hardware Specification*

5.2.7.2 Design Constraints

The ImageCast® Evolution has been designed to meet functional, performance, safety, regulatory, and cost requirements. Design constraints are covered in 2.04.1 - Democracy Suite® ImageCast® Evolution System Hardware Characteristics.

5.2.7.3 Applicable Standards

Applicable ImageCast® Evolution HW-related standards are covered in:

- *2.04 - Democracy Suite® ImageCast® Evolution System Hardware Specification*
- *2.04.1 - Democracy Suite® ImageCast® Evolution System Hardware Characteristics*

These documents include compliance and interface (Compact Flash, RS232, USB, etc.) standards.

5.2.8 ImageCast® Precinct System Constraints

5.2.8.1 Continuity of Operation

Please refer to the following TDP documents:

- *2.03 - Democracy Suite® ImageCast® Precinct Functionality Description,*
- *2.04 - Democracy Suite® ImageCast® Precinct Tabulator System Hardware Specification*
- *2.08 - Democracy Suite® ImageCast® Precinct System Operation Procedures*

5.2.8.2 Design Constraints

The ImageCast® Precinct has been designed to meet functional, performance, safety, regulatory and cost requirements. Such design constraints are covered in *2.04.1 - Democracy Suite® ImageCast® Precinct System Hardware Characteristics*.

5.2.8.3 Applicable Standards

Applicable ImageCast® Evolution Hardware-related standards are covered in:

- *2.04 - Democracy Suite® ImageCast® Precinct System Hardware Specification*

and

- *2.04.1 - Democracy Suite® ImageCast® Precinct System Hardware Characteristics*

These documents include compliance and interface (Compact Flash, RS232, USB, etc.) standards.

5.2.8.4 Compatibility

The ImageCast® Precinct system is compatible with VVSG 2005 Volume I and II requirements.

5.2.9 ImageCast® Central System Constraints

5.2.9.1 Design Constraints

ImageCast® Central hardware is based on two COTS devices which are selected to meet functional, performance, safety, and regulatory requirements. Design constraints for both COTS devices are covered in the scanner's and ImageCast® Central Workstation vendor's documentation.

5.2.9.2 Applicable Standards

Applicable ImageCast® Central Hardware-related standards are covered in the scanner's and ImageCast® Central Workstation vendor's documentation. If hardware related questions arise, please refer to the vendor's User manual that is provided with the hardware equipment or contact your vendor for support.

5.2.9.3 Compatibility

The ImageCast® Central system is compatible with VVSG 2005 Volume I and II requirements.

5.2.10 ImageCast[®] X System Constraints

5.2.10.1 Continuity of Operation

Please refer to the following TDP documents:

- *2.03 - Democracy Suite[®] ImageCast[®] X Functionality Description,*
- *2.08 - Democracy Suite[®] ImageCast[®] X System Operation Procedures*

5.2.10.2 Design Constraints

The ImageCast[®] X has been designed to meet functional, performance, safety, regulatory and cost requirements.

5.2.10.3 Applicable Standards

Applicable ImageCast[®] X Hardware-related standards are covered in the vendor's documentation. If hardware related questions arise, please refer to the vendor's User manual that is provided with the hardware equipment or contact your vendor for support.

5.2.10.4 Compatibility

The ImageCast[®] X system is compatible with VVSG 2005 Volume I and II requirements.

REVISION HISTORY

Rev.	Date	Author	Summary
7	06-05-2019	brian.fitzsimmons	Revised content in Sec3.1.2.1
6	05-30-2019	sava.antonijevic	Updated chapter 3.6 “ImageCast® X Operational Environment” with new tables 3-1 “ICX Configurations” and 3-2 “ICX Tabulator specifications”.
5	05-29-2019	brian.fitzsimmons	Content revisions throughout document to address TDP discrepancies.
4	05-27-2019	blair.beauchesne	Removed references to Avast Antivirus, replaced with Windows Defender.
3	04-18-2019	blair.beauchesne	Added “Golden Disc Images” to section 1.2 Relevant Disclaimers.
2	04-16-2019	brian.fitzsimmons	Content revisions throughout document to address discrepancies.
1	03-07-2019	brian.fitzsimmons	Created 5.11-CO branch from trunk

LIST OF FIGURES

Figure 2-1: Relationship Between the Democracy Suite [®] Components	4
Figure 2-2: Democracy Suite [®] High-level Block Diagram	12
Figure 2-3: The ImageCast [®] Precinct Ballot Counter	14
Figure 2-4: ImageCast [®] Evolution Ballot Counter in Operating Position.	17
Figure 2-5: ImageCast [®] Evolution Ballot Counter in Storage Position.	18
Figure 2-6: The ImageCast [®] Evolution Ballot Counter - Parallel Standard and AVS. .	20
Figure 2-7: Electronic Mobile Ballot	28
Figure 2-8: VVPAT ballot	29
Figure 3-1: The Democracy Suite [®] EMS Express Hardware Configuration.	36
Figure 3-2: The Democracy Suite [®] EMS Standard Configuration.	37
Figure 3-3: The ImageCast [®] Precinct Functional Block Diagram (with optional BMD). .	42
Figure 3-4: The ImageCast [®] Evolution Functional Block Diagram.	46
Figure 3-5: Prime	53
Figure 3-6: Classic	53
Figure 3-7: Samsung	53
Figure 3-8: BMD	53
Figure 3-9: VVPAT	53
Figure 4-1: The EMS EED Logical Input and Output Interfaces.	60

LIST OF TABLES

Table 2-1: Languages Supported by Democracy Suite 5.11	7
Table 2-2: Fonts to be used when rendering ballots that contain specific languages 8	
Table 3-1: ICX Configurations	54
Table 3-2: ICX Tabulator Specifications	55
Table 5-1: Democracy Suite® System Limits (Landscape Ballot Orientation)	74
Table 5-2: The Democracy Suite® System Limits (Portrait Ballot Orientation)	75
Table 5-3: ImageCast® Evolution Ballot Image Capacity for Various Ballot Sizes and Memory Card Sizes	77
Table 5-4: ImageCast® Precinct Ballot Image Capacity for Various Ballot Sizes and Memory Card Sizes	79

VVSG TRACE LIST

VVSG Criteria	Pg.
VVSG 1 Vol II - 2.1.1.1.a	1
VVSG 1 Vol II - 2.2.2	1
VVSG 1 Vol I - 8.7	1
VVSG 1 Vol II - 2.2	4
VVSG 1 Vol II - 2.2.1	4
VVSG 1 Vol I - 7.5.2	4
VVSG 1 Vol I - 4.1.7.2	22
VVSG 1 Vol II - 2.2.1.b	34
VVSG 1 Vol II - 2.2.1.c	34
VVSG 1 Vol I - 7.5.2	34
VVSG 1 Vol II - 4.7.1	44
VVSG 1 Vol II - 4.7.1	49
VVSG 1 Vol I - 7.5.2	57
VVSG 1 Vol II - 2.2.1	57
VVSG 1 Vol II - 2.5.8	57
VVSG 1 Vol II - 2.2.1.g	68
VVSG 1 Vol II - 2.2.2	74
VVSG 1 Vol II - 2.2.2.a	74
VVSG 1 Vol II - 2.2.2.b	74
VVSG 1 Vol II - 2.2.2.c	80
VVSG 1 Vol II - 2.2.2.d	80

End of Document

